







ASSEMBLY INSTRUCTION

Model: U5914-CRLS

Description: CONSOLE RECLINING LOVESEAT MANUAL

Thank you for purchasing this quality product. Be sure to check all packing material carefully for small parts that may have come loose inside the carton during shipment

PARTS LIST:

NO.	DESCRIPTION	SKETCH	Q'TY
A	Seat Body		1 PC
B	Left Backrest		1 PC
C	Console Backrest		1 PC
D	Right Backrest		1 PC
E	Left wing		1 PC
F	Right wing		1 PC

HARDWARE LIST:

NO.	DESCRIPTION	DESCRIPTION	SKETCH	QTY
1	Screw with handle	5/16"*50mm		2PCS

Step 1:

Important:

1. Attach Backrest (B/D) to the Seat (A).
2. Attach the Left/Right Wings (E/F) to the Left/Right side of the Backrest (B/D).

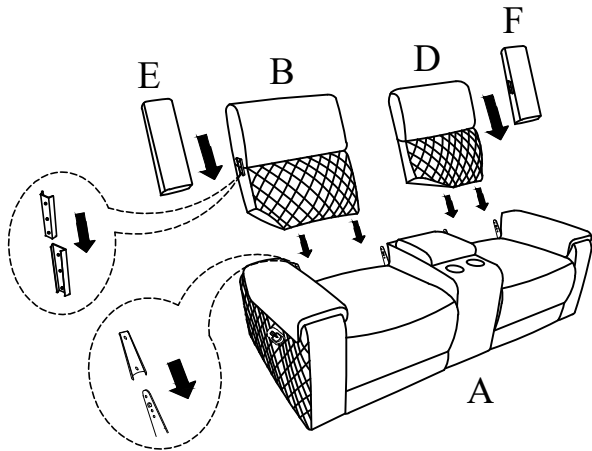

Step 2:

Important:

Take out the Knob Screws (1) at the Console Backrest (C) then place the Console Backrest (C) to right location and attach to the Seat (A) by turning the Knob Screws (1) clockwise.

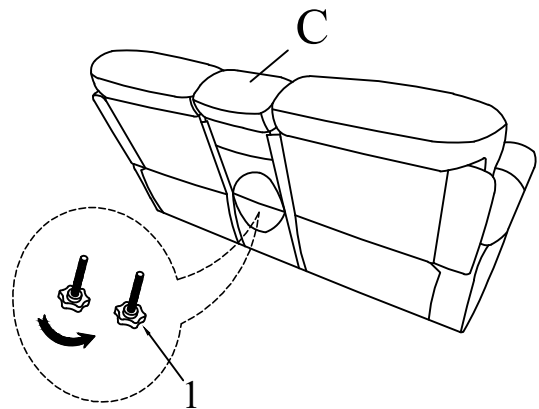

Step 3:

Important: Open the Footrest by pulling out the Switch.

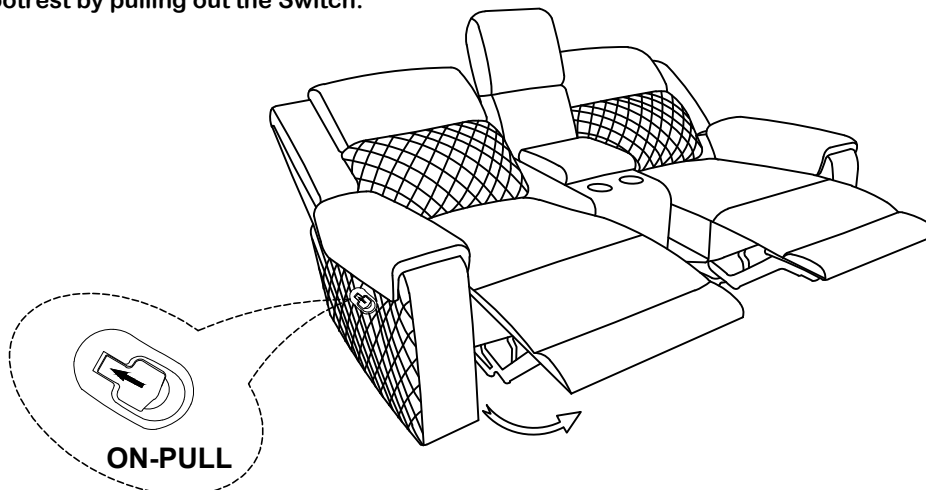





ASSEMBLY INSTRUCTION

Model: U5914-GR

Description: GLIDER RECLINER MANUAL

Thank you for purchasing this quality product. Be sure to check all packing material carefully for small parts that may have come loose inside the carton during shipment

PARTS LIST:

NO.	DESCRIPTION	SKETCH	Q'TY
A	Seat Body		1 PC
B	Backrest		1 PC
C	Left wing		1 PC
D	Right wing		1 PC

Step 1:

Important:

1. Attach Backrest (B) to the Seat (A).
2. Attach the Left/Right Wings (C/D) to the Left/Right side of the Backrest (B).

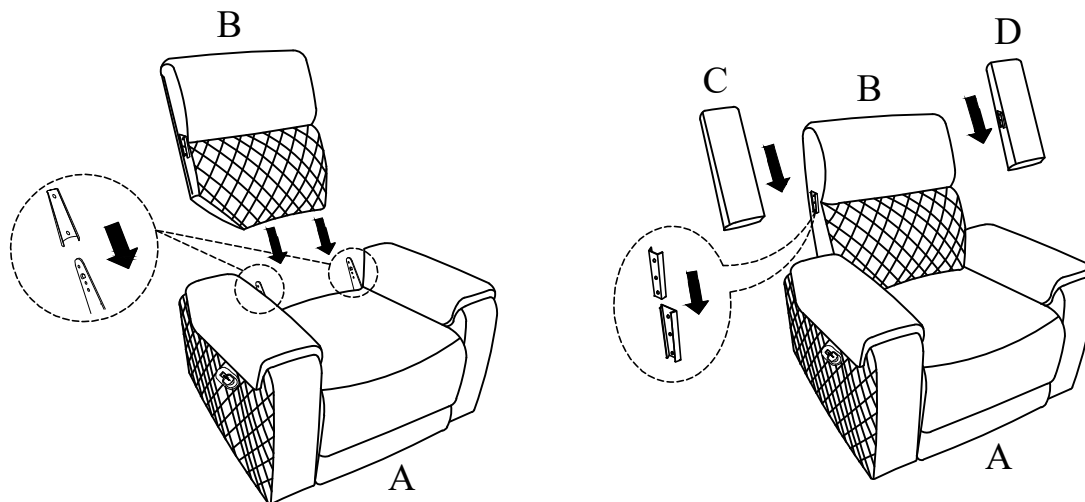

Step 2:

Important: Open the Footrest by pulling out the Switch.

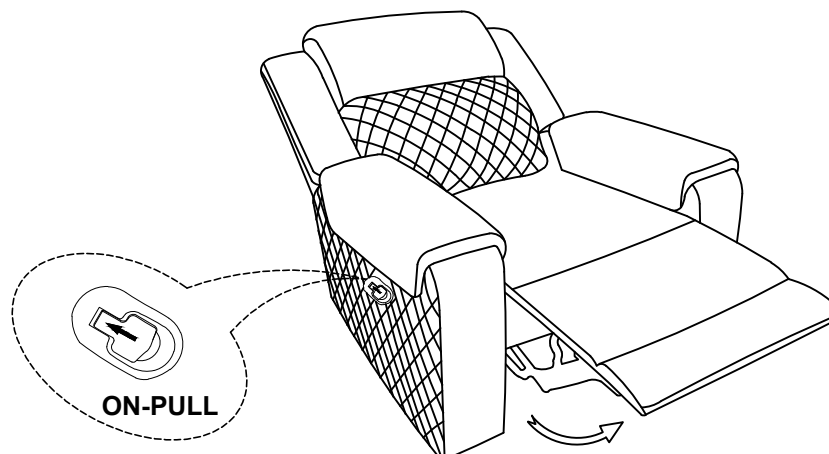

Made in Vietnam







ASSEMBLY INSTRUCTION

Model: U5914-RS

Description: RECLINING SOFA MANUAL

Thank you for purchasing this quality product. Be sure to check all packing material carefully for small parts that may have come loose inside the carton during shipment

PARTS LIST:

NO.	DESCRIPTION	SKETCH	Q'TY
A	Seat Body		1 PC
B	Left Backrest		1 PC
C	Middle Backrest		1 PC
D	Right Backrest		1 PC
E	Left wing		1 PC
F	Right wing		1 PC

Step 1:

Important:

1. Attach Backrest (B/C/D) to the Seat (A).
2. Attach the Left/Right Wings (E/F) to the Left/Right side of the Backrest (B/D).

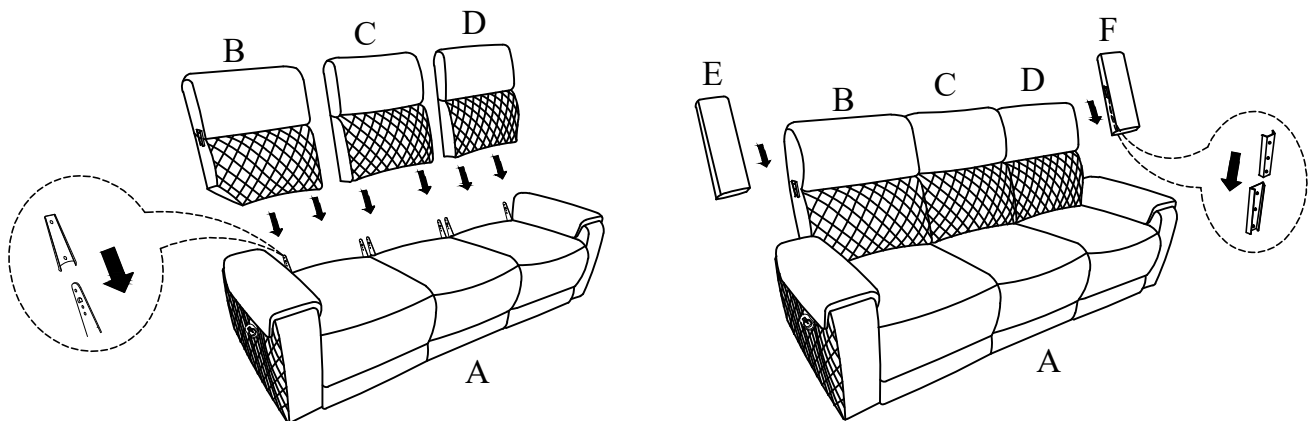

Step 2:

Important: Open the Footrest by pulling out the Switch.

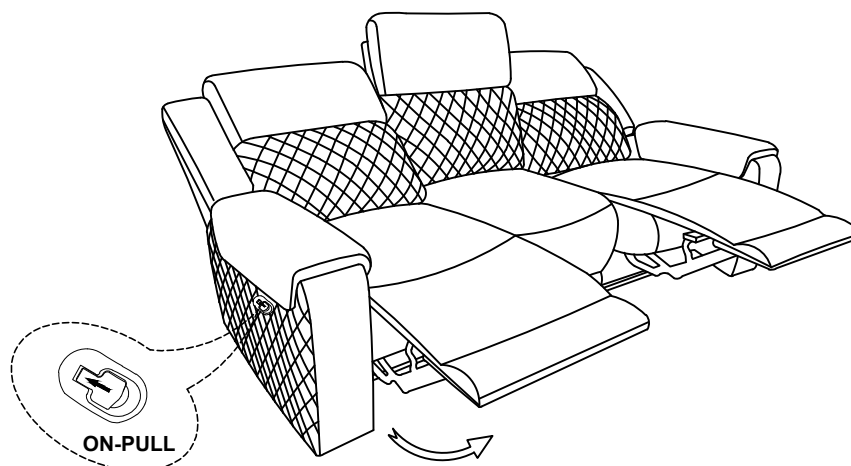

Made in Vietnam