







ASSEMBLY INSTRUCTION

Model: U1797-PRS



Description: RECLINING SOFA POWER

Thank you for purchasing this quality product. Be sure to check all packing material carefully for small parts that may have come loose inside the carton during shipment

PARTS LIST:

NO.	DESCRIPTION	SKETCH	Q'TY
A	Seat Body		1 PC
B	Left Backrest		1 PC
C	Middle Backrest		1 PC
D	Right Backrest		1 PC
E	Left wing		1 PC
F	Right wing		1 PC

HARDWARE LIST:

NO.	DESCRIPTION	DESCRIPTION	SKETCH	QTY
1	Plug			1 PC
2	Transformer			1 PC

Step 1:

Important:

1. Attach the Backrest (B/C/D) to the Seat (A).
2. Attach the Left/Right Wings (E/F) to the Left/Right side of the Backrest (B/D).

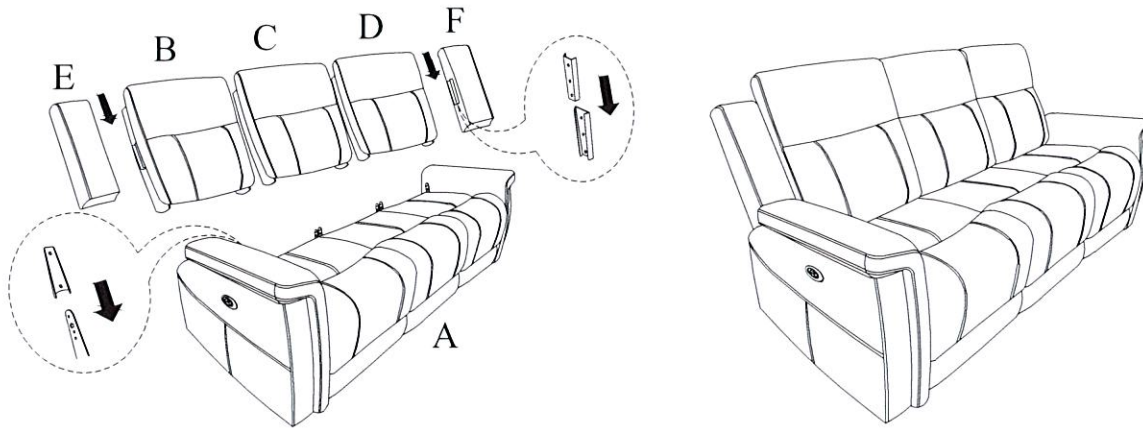

Step 2: Important:

1. Connect the power wire under the Armrest frame to the power source through out the Transformer (2) and The Plug (1).
2. Open the footrest or move the headrest by pressing the power button on/off.

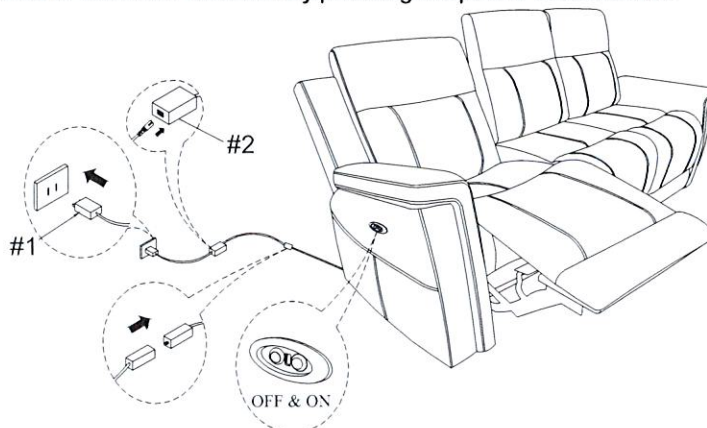

Made in Vietnam







ASSEMBLY INSTRUCTION

Model: U1797-PCRLS



Description: CONSOLE RECLINING LOVESEAT POWER

Thank you for purchasing this quality product. Be sure to check all packing material carefully for small parts that may have come loose inside the carton during shipment

PARTS LIST:

NO.	DESCRIPTION	SKETCH	Q'TY
A	Seat Body		1 PC
B	Left Backrest		1 PC
C	Console Backrest		1 PC
D	Right Backrest		1 PC
E	Left wing		1 PC
F	Right wing		1 PC

HARDWARE LIST:

NO.	DESCRIPTION	DESCRIPTION	SKETCH	QTY
1	Plug			1 PC
2	Transformer			1 PC

Step 1:

Important:

1. Attach the Backrest (B/C/D) to the Seat (A).
2. Attach the Left/Right Wings (E/F) to the Left/Right side of the Backrest (B/D).

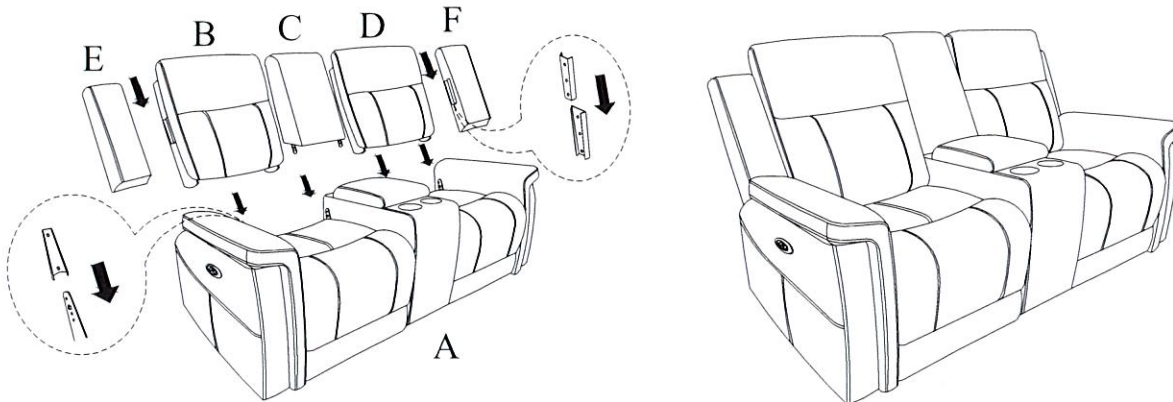

Step 2: Important:

1. Connect the power wire under the Armrest frame to the power source through out the Transformer (2) and The Plug (1).
2. Open the footrest or move the headrest by pressing the power button on/off.

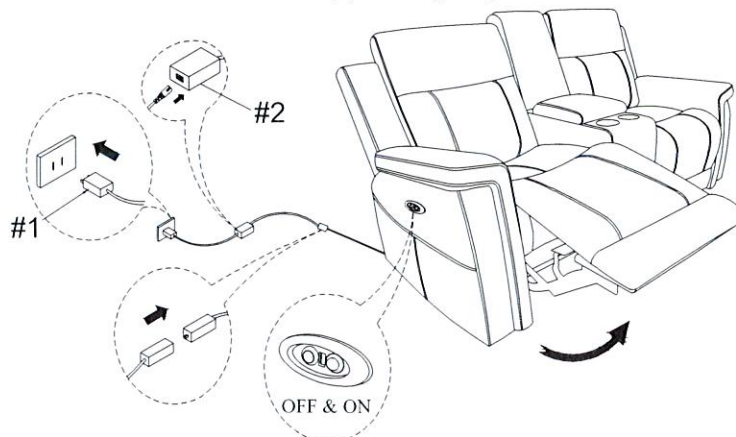

Made in Vietnam





ASSEMBLY INSTRUCTION

Model: U1797-PGR



Description: GLIDER RECLINER POWER

Thank you for purchasing this quality product. Be sure to check all packing material carefully for small parts that may have come loose inside the carton during shipment

PARTS LIST:

NO.	DESCRIPTION	SKETCH	Q'TY
A	Seat Body		1 PC
B	Backrest		1 PC
C	Left wing		1 PC
D	Right wing		1 PC

HARDWARE LIST:

NO.	DESCRIPTION	DESCRIPTION	SKETCH	QTY
1	Plug			1 PC
2	Transformer			1 PC

Step 1:

Important:

1. Attach the Backrest (B) to the Seat (A).
2. Attach the Left/Right Wings (C/D) to the Left/Right side of the Backrest (B).

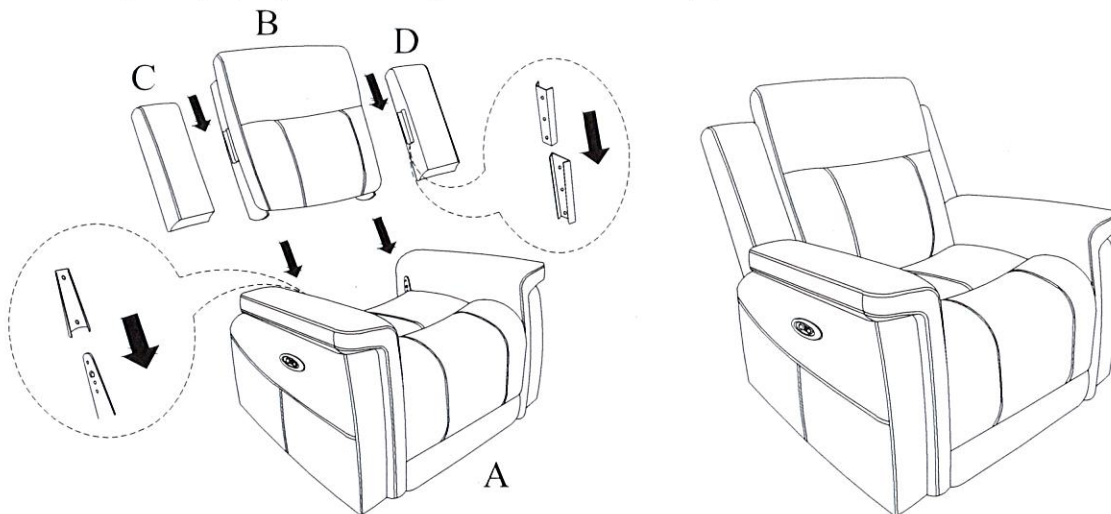

Step 2:

Important:

1. Connect the power wire under the Armrest frame to the power source through out the Transformer (2) and The Plug (1).
2. Open the footrest or move the headrest by pressing the power button on/off.

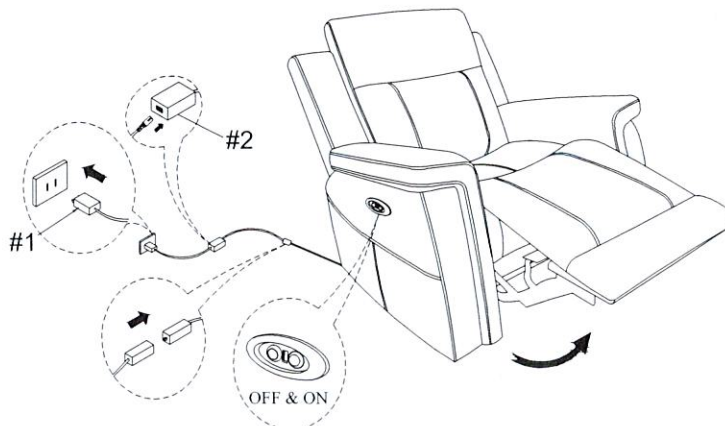

Made in Vietnam