

ASSEMBLY INSTRUCTION

















Model : NOLAN-GREY
-QB-HB-QB-STORAGE-FB-QB-STORAGE-SR

Description : QUEEN BED STORAGE FOOTBOARD
W/SLATS

Thank you for purchasing this quality product. Be sure to check all packing material carefully for small parts that may have come loose inside the carton during shipment.

PART LIST :

HARDWARE LIST :

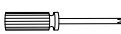
No.	Description	Diagram	Quantity	No.	Description	Diagram	Size	Quantity
A	HEADBOARD		1	I	JCBC SCREW		M6 x 35mm	6
B	FOOTBOARD		1	J	SPRING WASHER		M6 x 13mm	6
C	DRAWER FRAME WITH DRAWER		1	K	FLAT WASHER		M6 x 19mm	6
D	SIDE RAIL		2	L	JCBB SCREW		M8 x 25mm	8
E	SUPPORT LEG FOR DRAWER FRAME		2	M	SPRING WASHER		M8 x 15mm	8
F	WOODEN SLAT		12	N	FLAT WASHER		M8 x 22mm	8
G	CENTER RAIL		2	O	CB SCREW		M4 x 32mm	24
H	WOODEN SUPPORT		4	P	ALLEN KEY		M4	1
				Q	ALLEN KEY		M5	1
				R	SCREW DRIVER (*)			1

Led Touch Sensor :
i) Switch on
ii) Lighter
iii) More lighter
iv) Switch off

(*) The manufacturer does not provide item R.

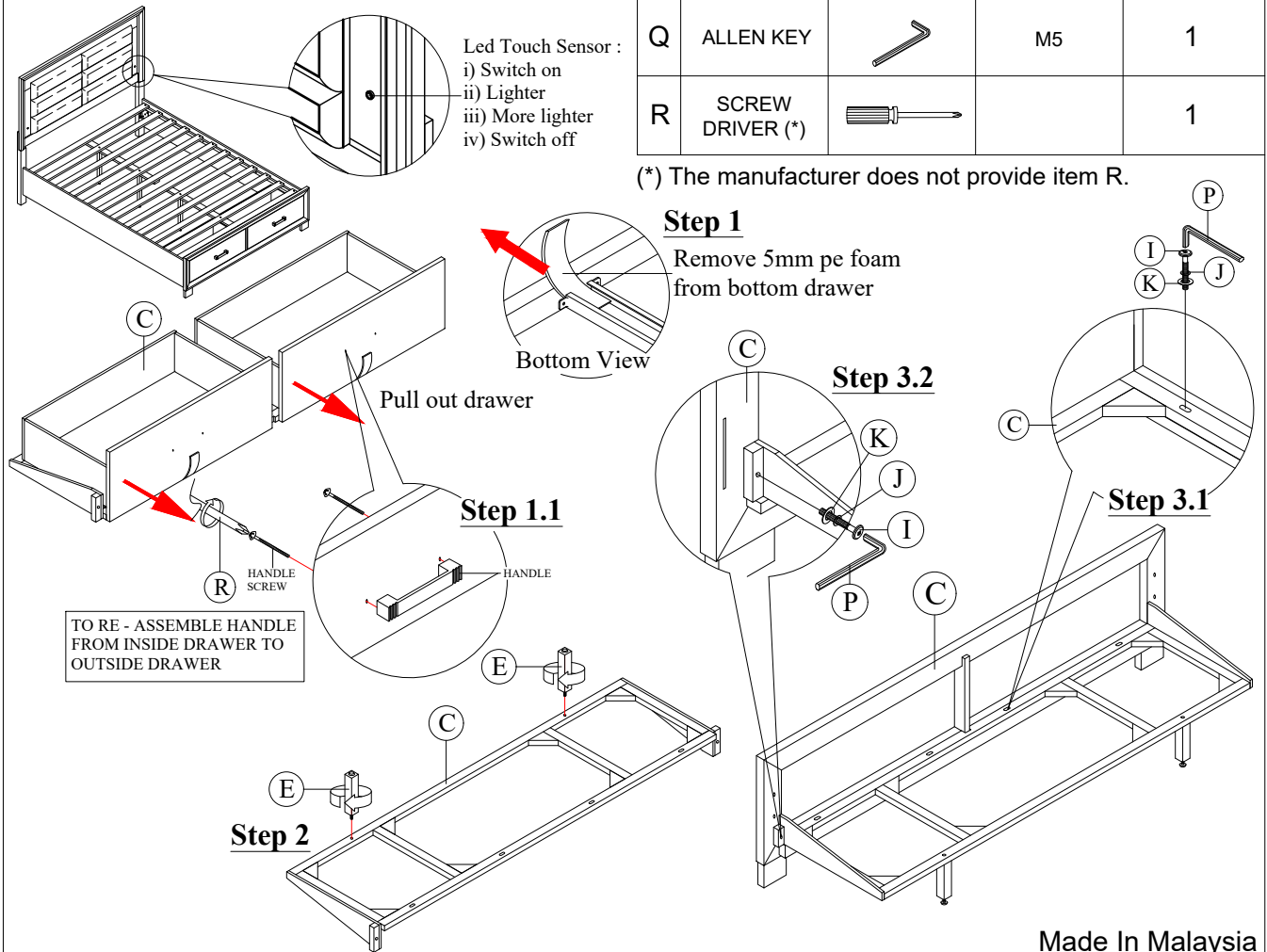

Made In Malaysia

ASSEMBLY INSTRUCTION

Model : NOLAN-GREY
-QB-HB-QB-STORAGE-FB-QB-STORAGE-SR

Description : QUEEN BED STORAGE FOOTBOARD
W/SLATS

Thank you for purchasing this quality product. Be sure to check all packing material carefully for small parts that may have come loose inside the carton during shipment.

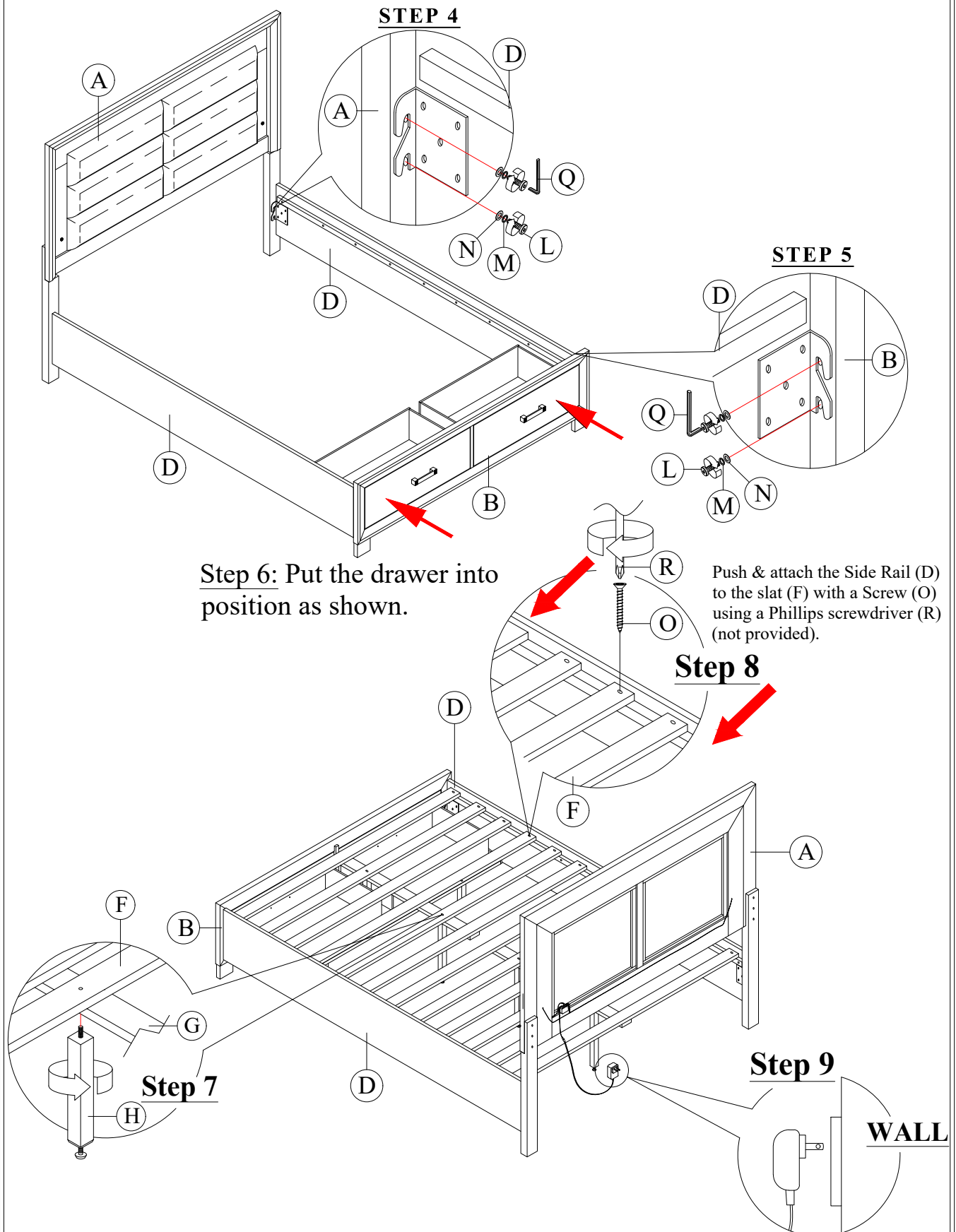









Made In Malaysia

ASSEMBLY INSTRUCTION

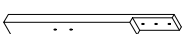
Model : NOLAN-GREY-QB-HB

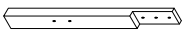
Description : QUEEN BED-HEADBOARD

Thank you for purchasing this quality product. Be sure to check all packing material carefully for small parts that may have come loose inside the carton during shipment.

PART LIST :				HARDWARE LIST :				
No.	Description	Diagram	Quantity	No.	Description	Diagram	Size	Quantity
A	HEADBOARD		1	D	JCBB SCREW		M8 x 40mm	6
B	LEFT HEADBOARD LEG		1	E	SPRING WASHER		M8 x 15mm	6
C	RIGHT HEADBOARD LEG		1	F	FLAT WASHER		M8 x 22mm	6
				G	ALLEN KEY		M5	1
				H	ADAPTOR			1

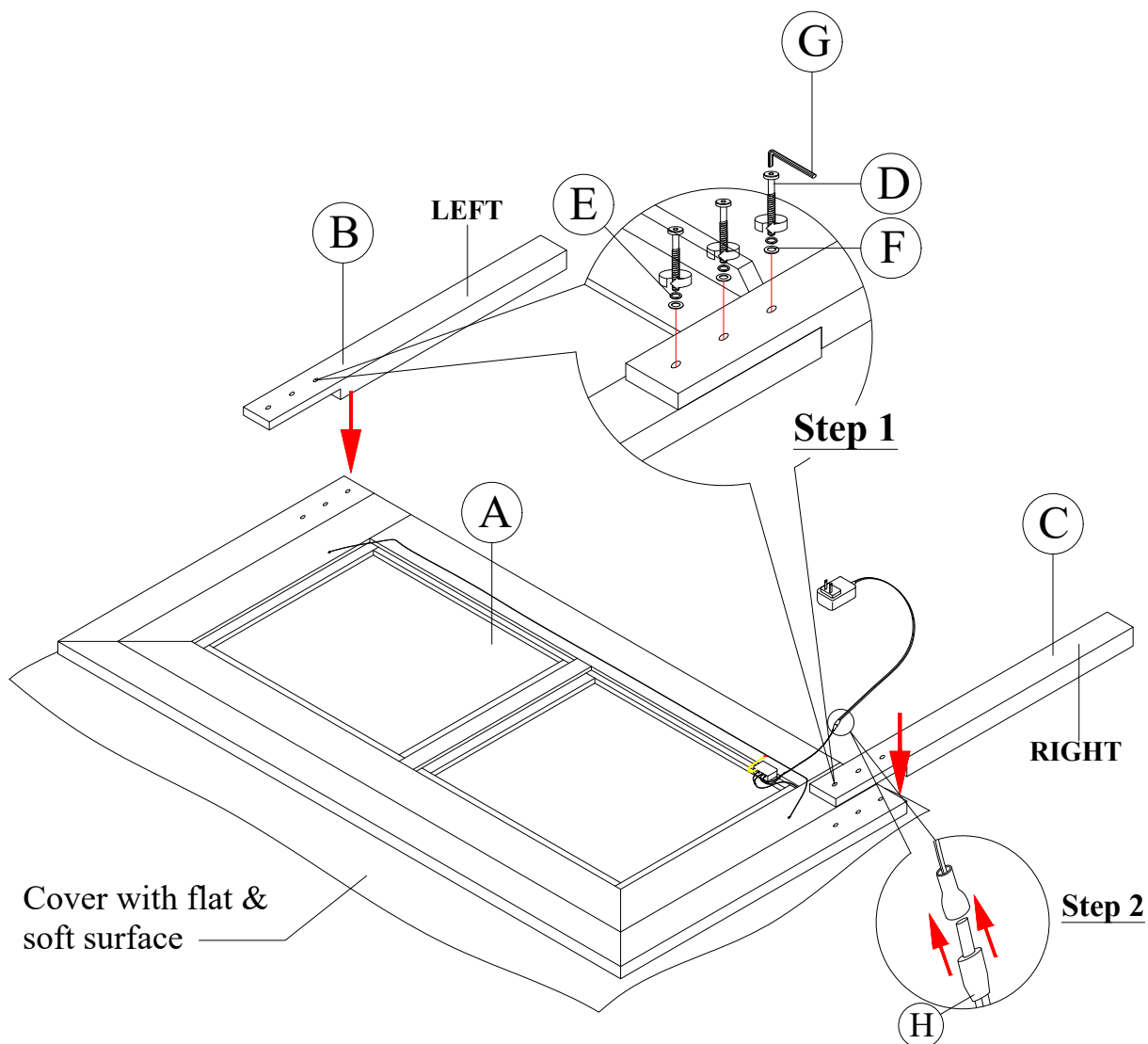

Made In Malaysia

2207GR QUEEN HB