

ASSEMBLY INSTRUCTION













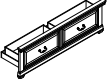

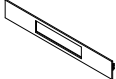

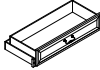
Model : ROWAN/TATUM-NATURAL/GREY
 -QB-HB-QB-STORAGE-FB-QB-STORAGE-SR-SR DRAWERS

Description : QUEEN BED STORAGE
 FOOTBOARD W/SLATS

Thank you for purchasing this quality product. Be sure to check all packing material carefully for small parts that may have come loose inside the carton during shipment.

PART LIST :

HARDWARE LIST :

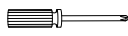
No.	Description	Diagram	Quantity	No.	Description	Diagram	Size	Quantity
A	HEADBOARD		1	H	JCBB SCREW		M8 x 25mm	8
B	FOOTBOARD STORAGE		1	I	SPRING WASHER		M8 x 15mm	8
C	STORAGE SIDE RAIL		2	J	FLAT WASHER		M8 x 22mm	8
D	STORAGE DRAWER		2	K	JCBB SCREW		M6 x 35mm	8
E	WOODEN SLAT		12	L	SPRING WASHER		M6 x 13mm	8
F	CENTER RAIL		2	M	FLAT WASHER		M6 x 19mm	8
G1	WOODEN SUPPORT		4	N	CB SCREW		M4 x 32mm	24
G2	WOODEN SUPPORT FOR DRAWER		4	O	ALLEN KEY		M5	1
				P	ALLEN KEY		M4	1
				Q	SCREW DRIVER (*)			1

(*) The manufacturer does not provide item Q.

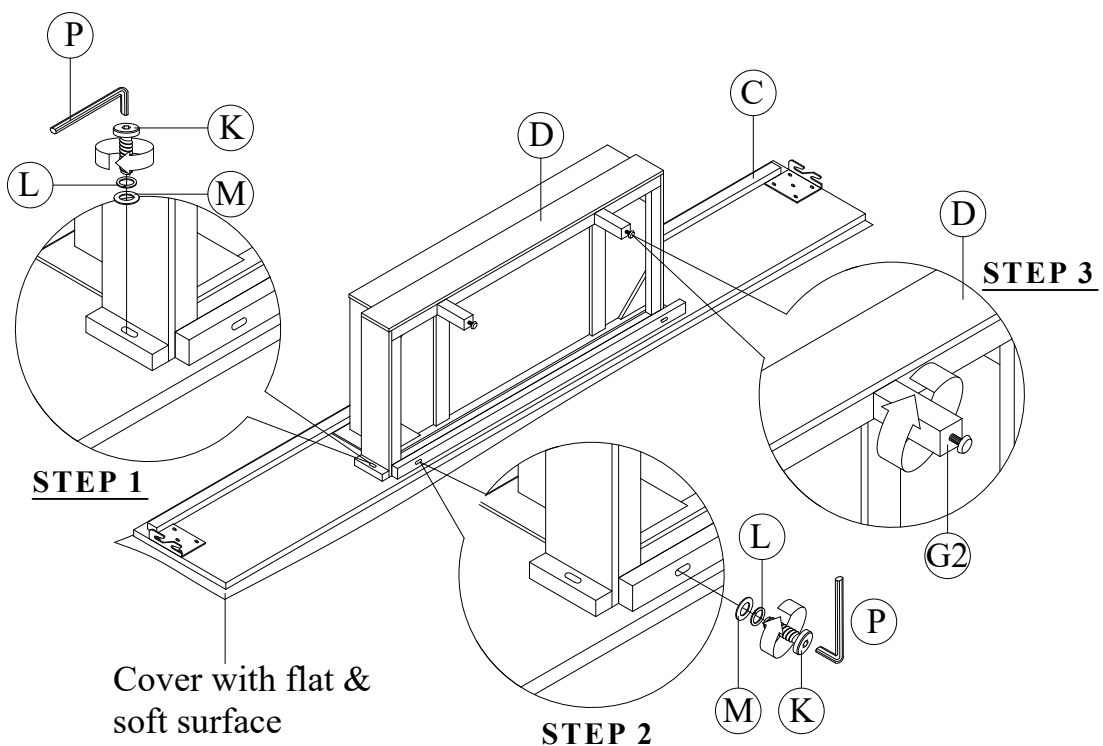

Made In Malaysia

ASSEMBLY INSTRUCTION

Model : ROWAN/TATUM-NATURAL/GREY
-QB-HB-QB-STORAGE-FB-QB-STORAGE-SR-SR DRAWERS

Description : QUEEN BED STORAGE
FOOTBOARD W/SLATS

Thank you for purchasing this quality product. Be sure to check all packing material carefully for small parts that may have come loose inside the carton during shipment.

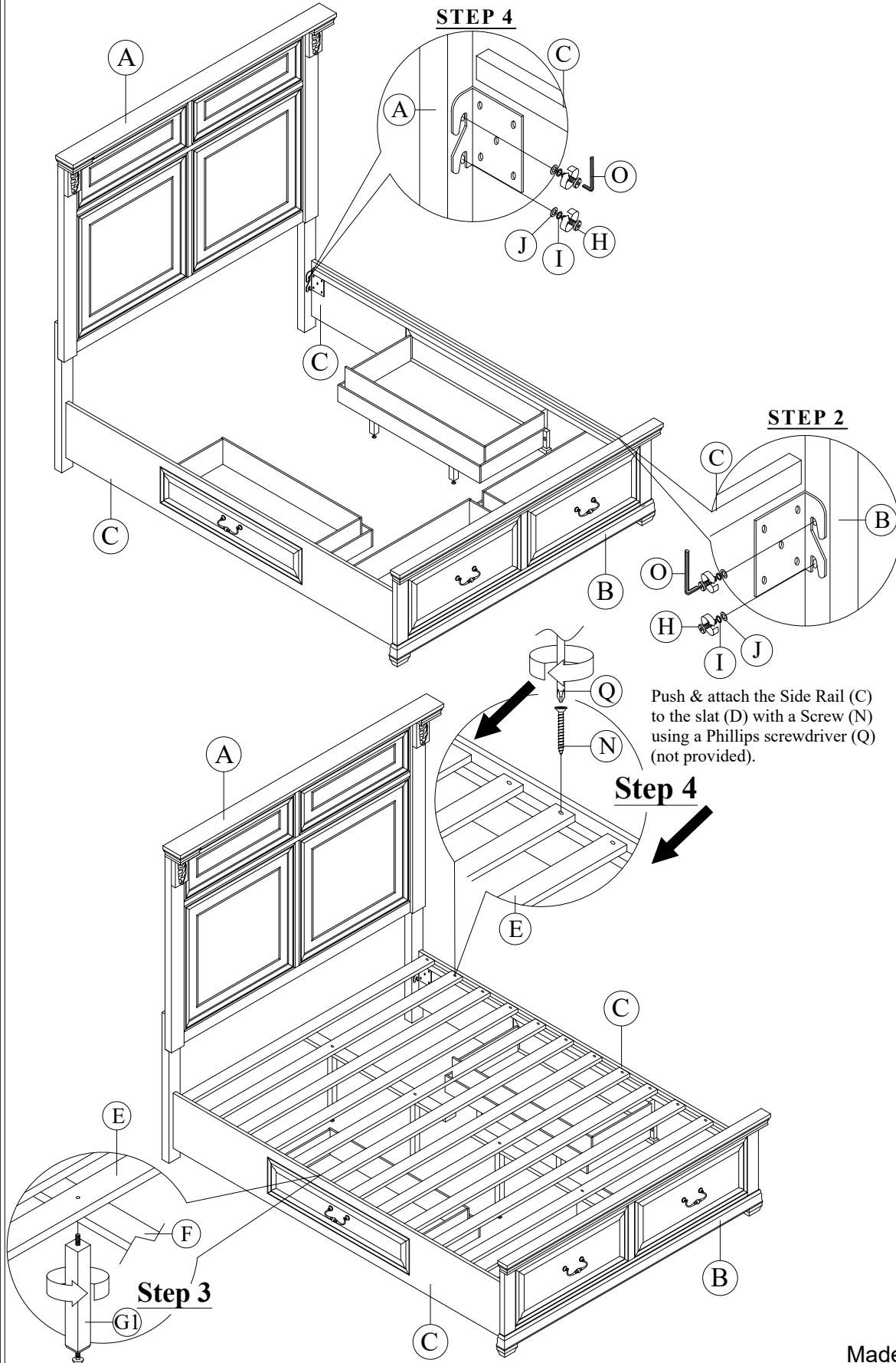

Made In Malaysia