

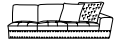





INSTALLATION MANUAL

ITEM NAME

M: U 97

A		X 1
B		X 1
C		X 9
D		X 1
E		X 36
F		X 1

STEP 1: PLUG IN THE BACKREST FOR A & B

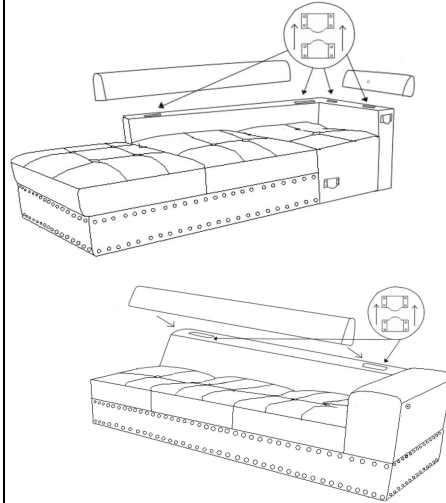

STEP 2 : PILLOW & LEG LOCATION FOR A

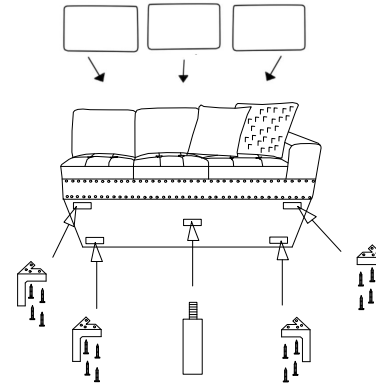

STEP 3 : PILLOW & LEG LOCATION FOR B

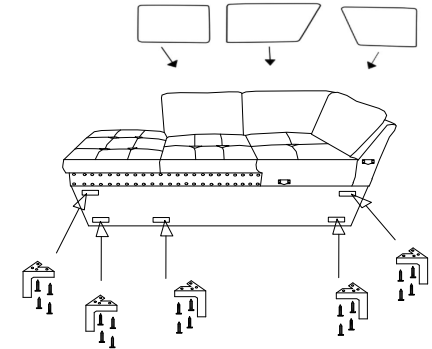

STEP 4 : DETACH LED WIRE HARNESS ENDS FROM METAL BRACKET CONNECTORS ON SOFA AND LOVESEAT. CONNECT BOTH LED WIRE HARNESS END FIRST THEN INSTALL BRACKET CONNECTORS TOGETHER TO CONNECT SOFA TO LOVESEAT.

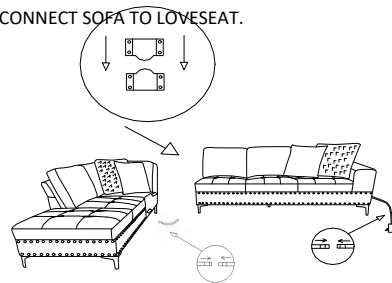

STEP 5 : TAP TOUCH SENSOR TO TURN THE LED ON/OFF

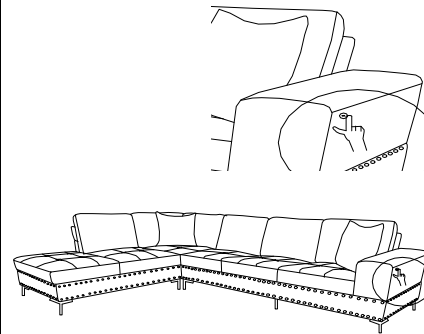

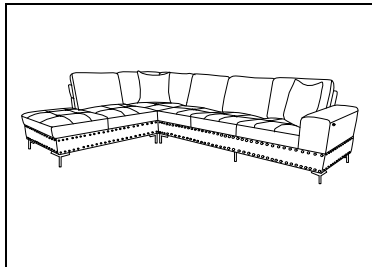
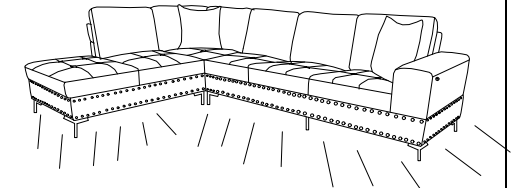

STEP 6



INSTALLATION MANUAL

ITEM NAME

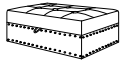
M: STOOL U 97

A		X 1
B		X 4
C		X 16

STEP 1

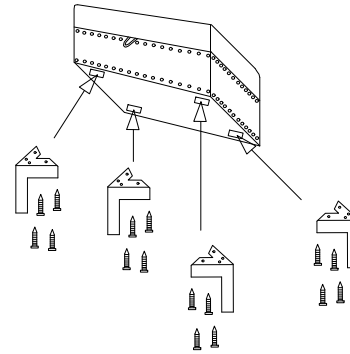

STEP 2

