

Assembly Instruction: Model: U6008

Assembly Parts Desc.		Sofa	Loveseat
A		Metal Leg	4 pcs
B		JCBC Bolts M8x20mm	8 pcs
C		Allen Key M5x65mm	1 pc
D		Center Support Leg	1 pc
E		Plastic Washer	1 pc

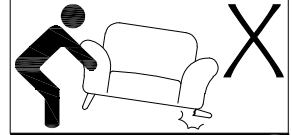
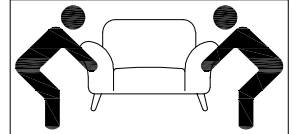

2 PERSONS RECOMMENDED

- Do not use power tools.
- Do not over-tight.
- Keep the packing materials and small parts out of reach of children.

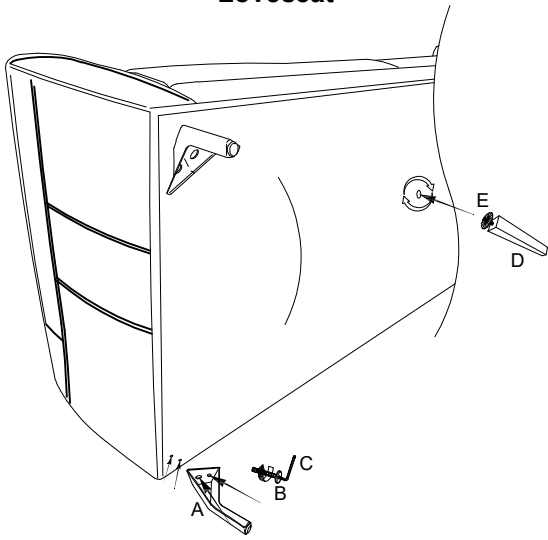
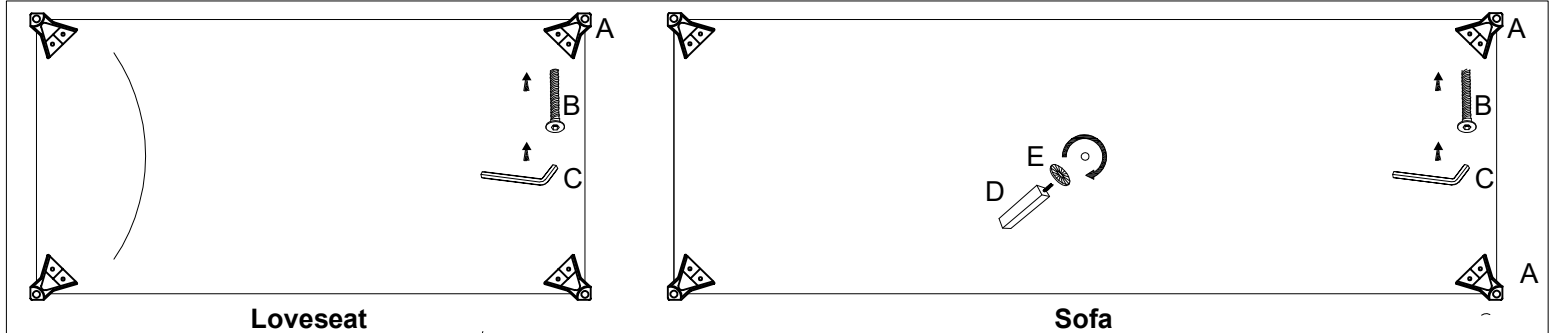

Step 1 :
Take the parts out from zipper pouch of bottom product.

Step 2 :
Place a metal leg (A) on to the bottom of the upholstery that you are building. Make sure the hole on the metal leg (A) aligns with the hole on the bottom of the upholstery. Tighten the metal leg (A) with the bolt (B) by using the allen key(C).

Step 3 :
For the center leg, there is hole at the center on the bottom of sofa. Please put the center leg (D) together with plastic washer (E), tighten up the center leg by turn it clockwise.

Completed

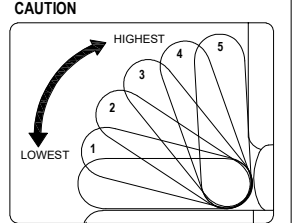
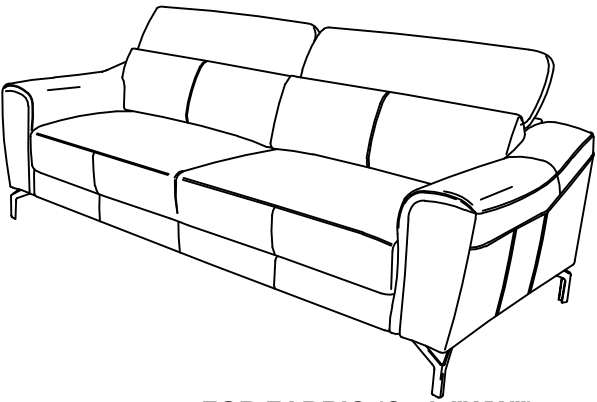
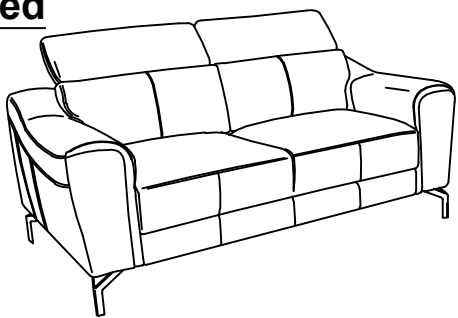

CAUTION
THIS SOFA HAS ADJUSTABLE HEADREST (6 MOTIONS)
TO REMOVE THE HEADREST BACK TO ORIGINAL POSITION
PLEASE PULL TO HIGHEST POSITION THEN SLOWLY LET HEADREST BACK TO LOWEST POSITION
PLEASE DO NOT SIT ON HEADREST WHEN NO BACK TO ORIGINAL POSITION

FOR LEATHER AND P.U (Code"X")
Clean by lightly brushing and vacuuming only to remove dust and particles buildup. Water-based foam cleaner or solvent based cleaning agents of any kind may cause excessive shrinking, staining or distortion of the surface pile and, therefore, should not be used.

FOR FABRIC (Code"WW")
-Use water-based agents only.
-Do not use solvents.
-Gently remove stains by blotting or hang washing.
-Do not use excessive brushing or rubbing.