





# ASSEMBLY INSTRUCTIONS

**MODEL : 0361A/B & 0362A**  
**YLIME**  
**E.KING (4+8)**





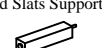

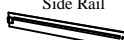
**(Box 1)**  
 BOX OF HEADBOARD & FOOTBOARD

No	ITEM	Qty
A	Headboard 	1 pc
B	Footboard 	1 pc
C	Headboard Leg (L/R) 	2 pcs
D	Bed Slats 	4 pcs
E	Bed Slats Support 	8 pcs

**(Box 2)**  
 BOX OF SIDE RAIL

No	ITEM	Qty
F	Side Rail 	2 pcs

**(Box 1)**  
 HARDWARE LIST

No	ITEM	Qty
1	Csk M4 x 32mm 	8 pcs
2	JCBC Bolt m6x30mm Blk 	6 pcs
3	Spring Washer 1/4" Blk 	6 pcs
4	Flat Washer 1/4"IDx13mmOD Blk 	6 pcs
5	ALLEN KEY m4x65mm Blk 	1 pc
6	ALLEN KEY m5x65mm Blk 	1 pc
7	12V+12W+1A Adaptor With ETL Certificate 	1 pc

**STEP 1 :** Attach Head Board Leg ( C ) to Head Board ( A ) . Insert Spring Washer (3), Flat washer (4),tighten JCBC (2) using an Allen Key ( 5 ) .

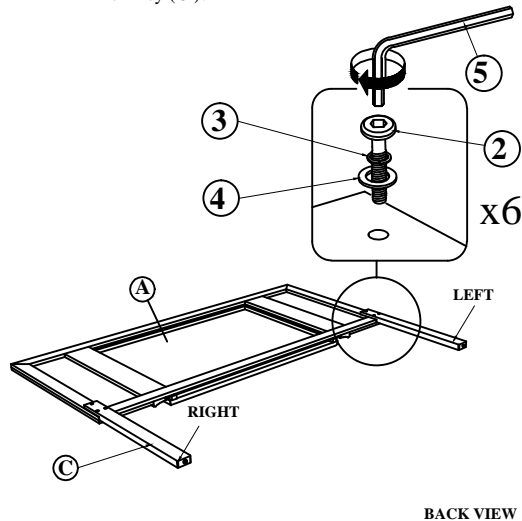

**STEP 2 :** Hook SIDE RAIL (F) TO HEAD BOARD (A) closely and push down to fit. repeat step 2 with other end of rail to hook onto FOOTBOARD (B).

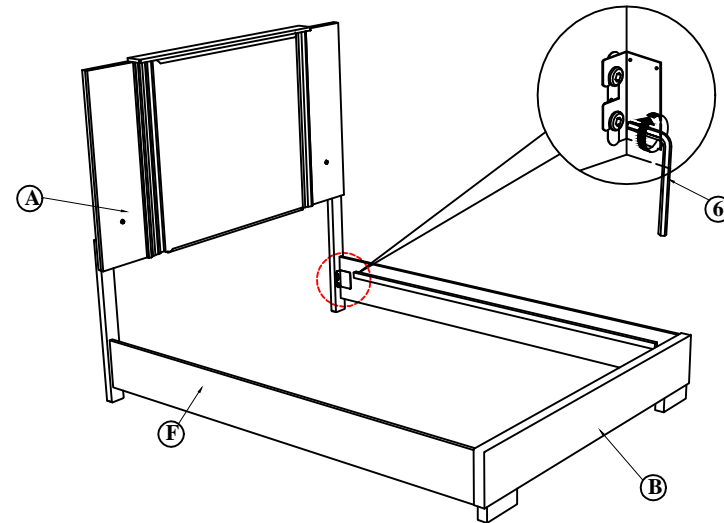

**STEP 3 :** Tighten the 4 Corner with Allen Key (6).Fix the Bed Slat Support Leg (E) , to Bed Slat (D) as shown . Install the bed slat ( D ) to side rail ( F ) and tighten with Csk Screw ( 1 ) as per diagram shown. (NOTE: THE SETUP MUST DONE AT THE DECIDED LOCATION FOR THE BED TO OBTAIN PERFECT STABILITY)

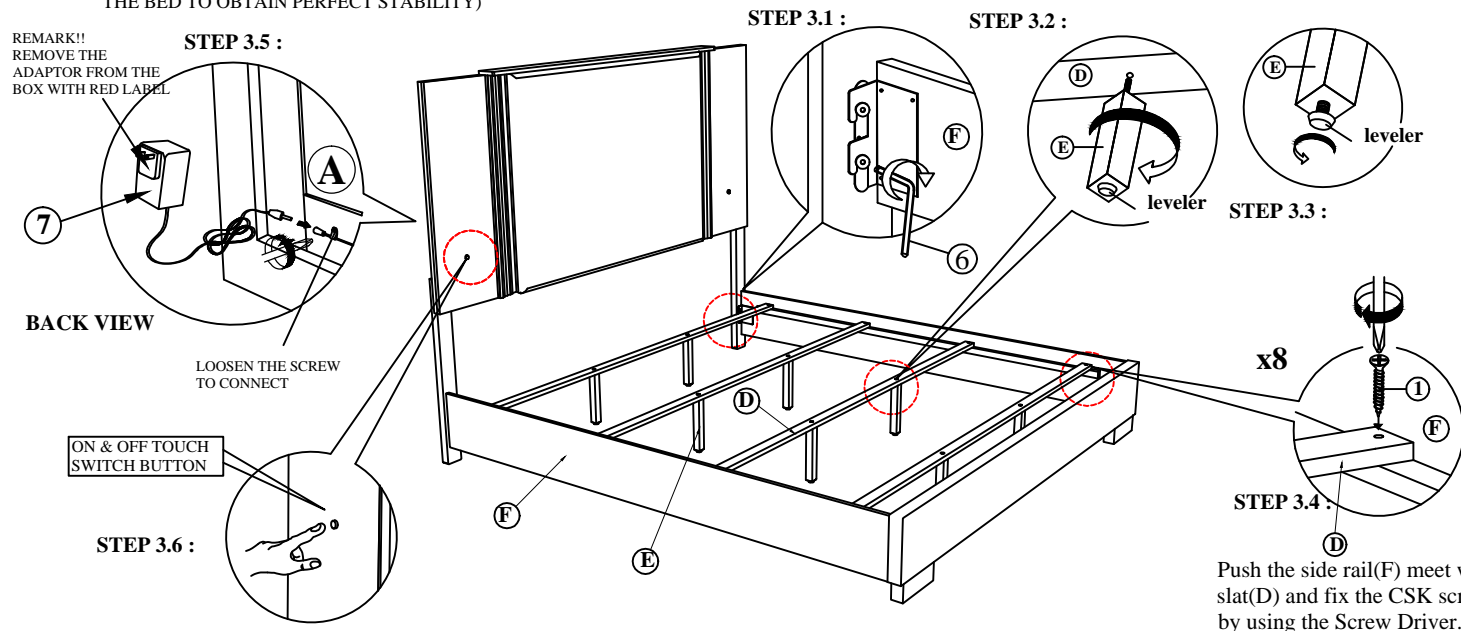

**NOTE :** MUST TIGHTEN SCREWS PERIODCALLY WITH USE SCREW WILL BECOME LOOSE CHECK TIGHTNESS OF ALL SCREW EVERY 6-8 WEEKS.