







# ASSEMBLY INSTRUCTION

MODEL NO: EK KING HEADBOARD

ITEM	DRAWING	DESCRIPTION	QTY
A		HEADBOARD PANEL	1
B		LEFT HEADBOARD LEG	1
C		RIGHT HEADBOARD LEG	1

ITEM	DRAWING	DESCRIPTION	QTY
D		JCBB SCREW (M8 x 40mm)	6
E		SPRING WASHER (M8 x 15mm)	6
F		FLAT WASHER (M8 x 22mm)	6
G		ALLEN KEY (M5)	1

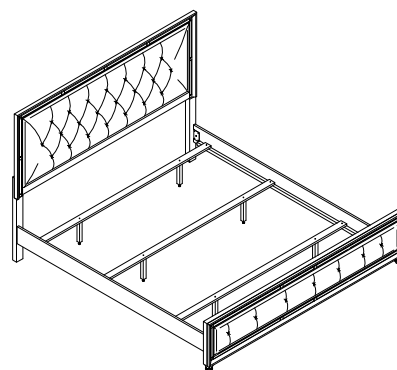

**COMPLETED EK KING BED ASSEMBLY**

## Step 1

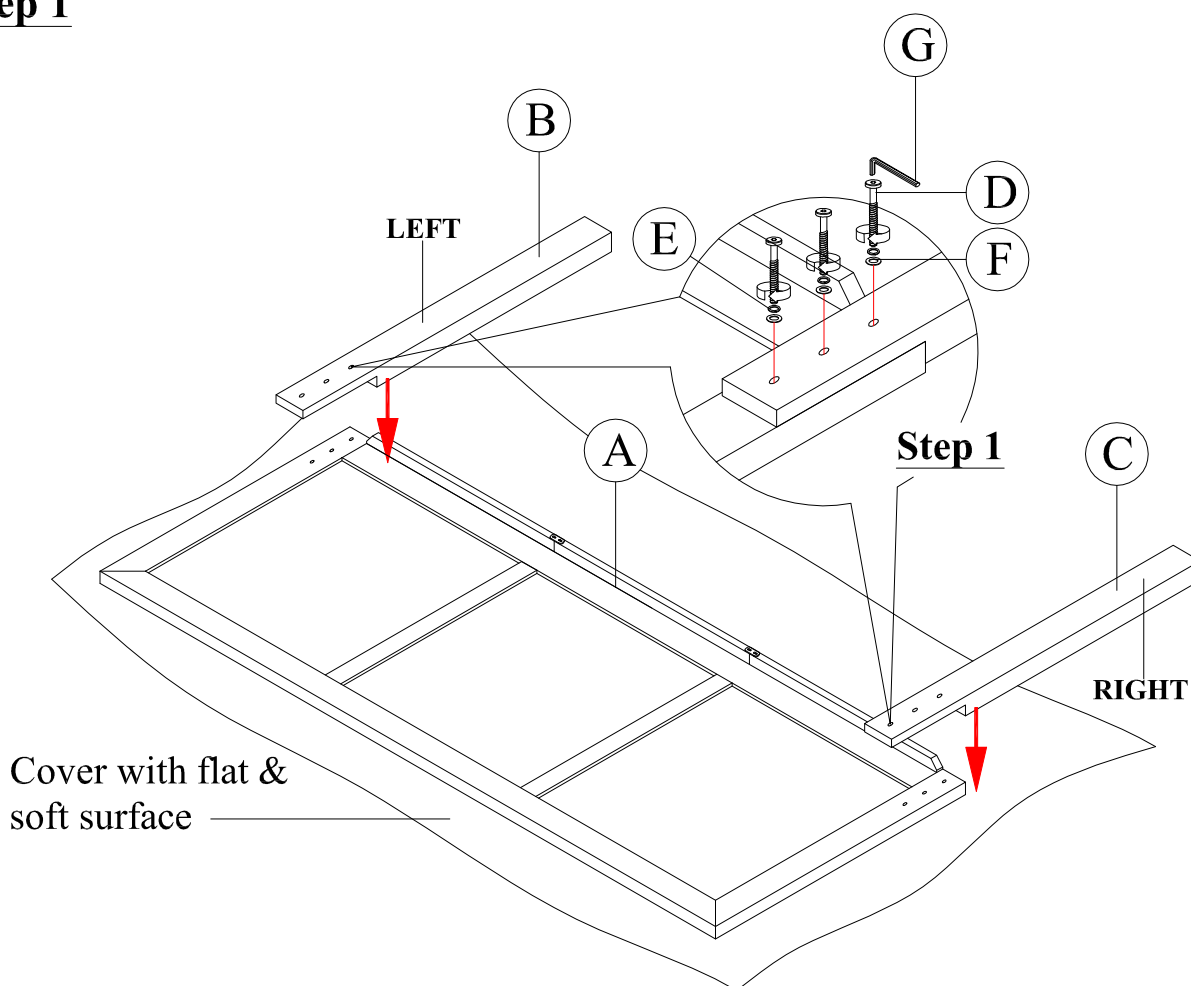

NOTE : MUST TIGHTEN SCREWS PERIODICALLY. WITH USE SCREWS MAY BECOME LOOSE.  
CHECK TIGHTNESS OF ALL SCREWS EVERY 6-8 WEEKS.

### CLEANING INSTRUCTION

After assembled, clean & polish the completed parts if necessary with soft cloth and industrial recognized furniture polish

MADE IN MALAYSIA