

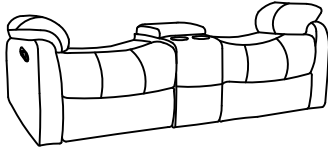

# Assembly Instruction

## PART LIST

NO.	DRAWING	QTY	DESCRIPTION
A		1	SEAT
B		1	LSF BACK REST
C		1	RSF BACK REST
D		1	CONSOLE BACK REST
E		1	LSF EAR
F		1	RSF EAR

Please follow the drawings below to assemble the item

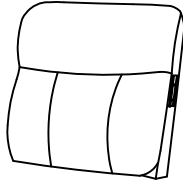
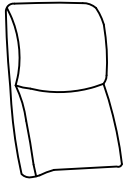
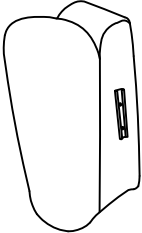
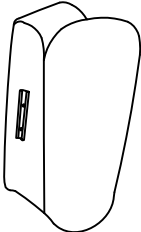
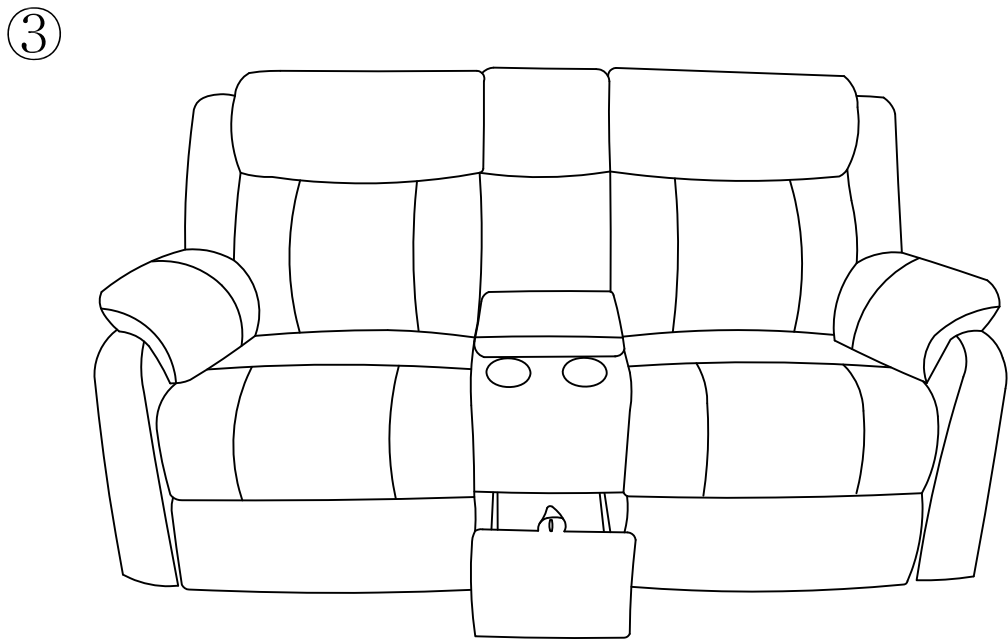
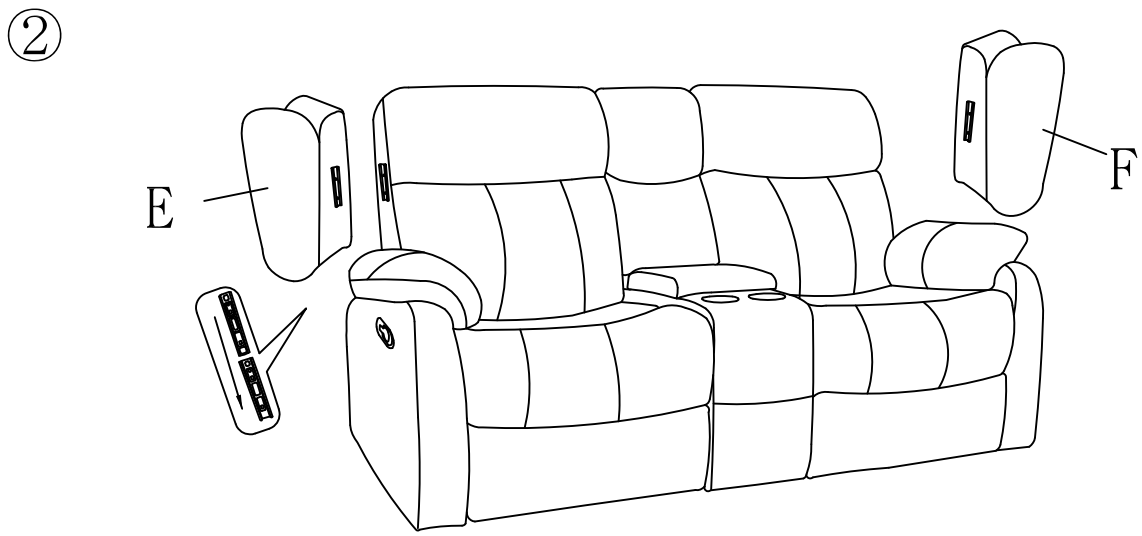
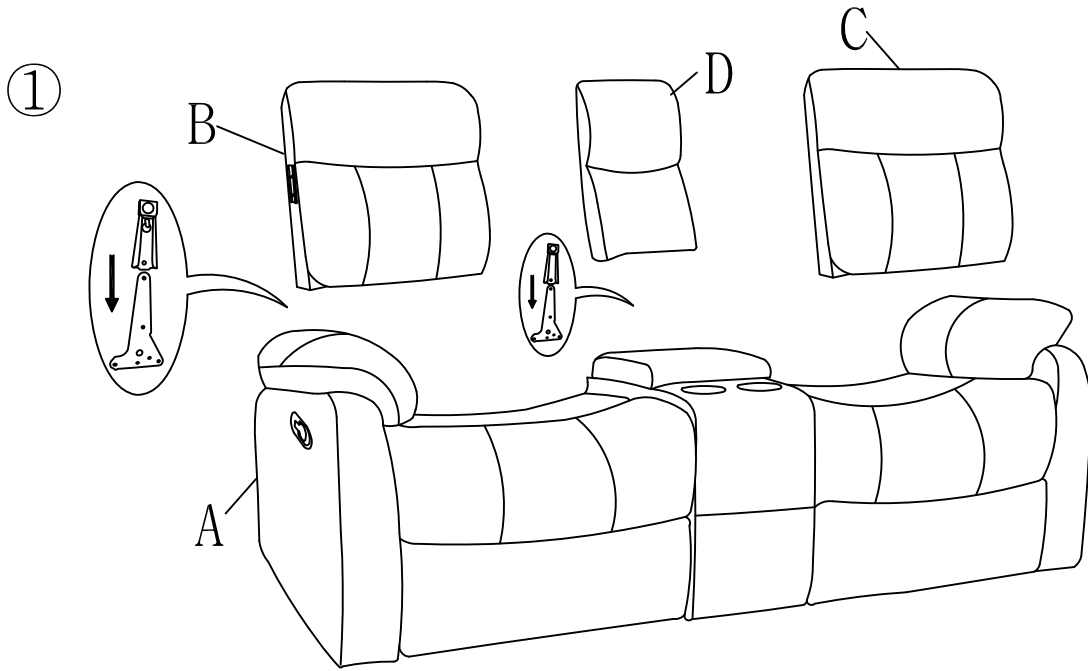

# Assembly Instruction

## PART LIST

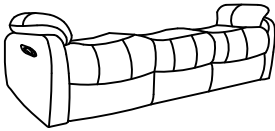
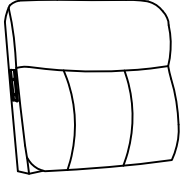
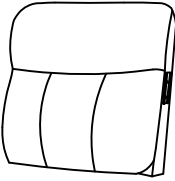
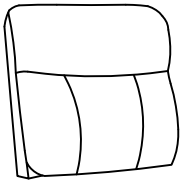
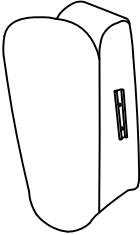
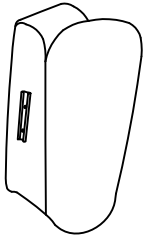
NO.	DRAWING	QTY	DESCRIPTION
A		1	SEAT
B		1	LSF BACK REST
C		1	RSF BACK REST
D		1	MIDDLE BACK REST
E		1	LSF EAR
F		1	RSF EAR

Please follow the drawings below to assemble the item

①

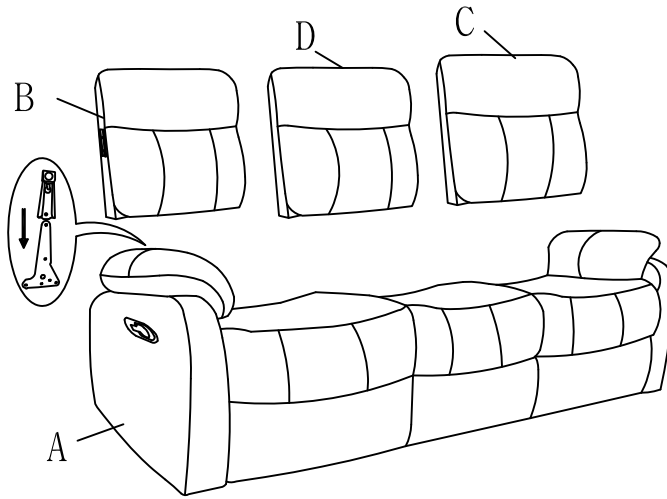

②

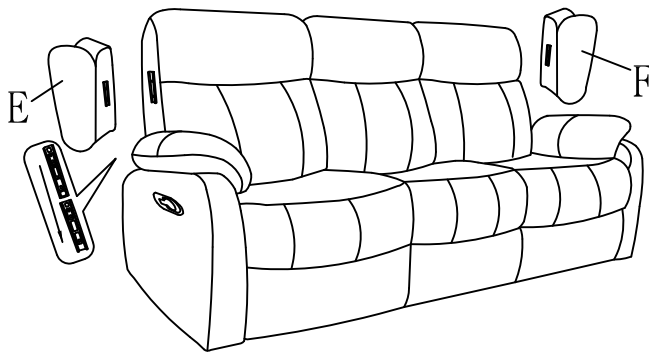

③

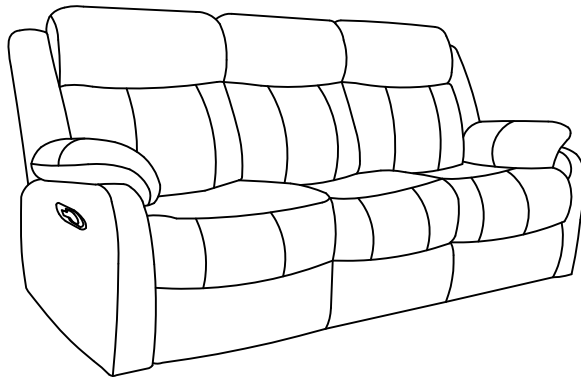

④

