

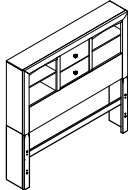

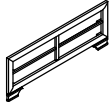

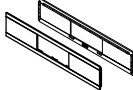





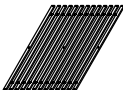

ASSEMBLY INSTRUCTION







MODEL NO: JORDYN - WHITE / GREY - FB - HB - STORAGE & LIGHT DESCRIPTION: FULL STORAGE HEADBOARD W/LIGHT
 JORDYN - WHITE / GREY - FB - FB - FRAME & SLATS FULL STORAGE FOOTBOARD W/FRAME & SLATS
 JORDYN - WHITE / GREY - FB - FB & SR DRAWER 1 FULL 2PCS FOOTBOARD DRAWER & 1PC SIDE RAILS DRAWER
 JORDYN - WHITE / GREY - FB - FB & SR DRAWER 2 FULL 2PCS FOOTBOARD DRAWER & 1PC SIDE RAILS DRAWER
 JORDYN - WHITE / GREY - FB - SR & CENTER STORAGE FULL SIDE RAIL & CENTER STORAGE

Thank you for purchasing this quality product. Be sure to check all packing material carefully for small parts that may have come loose inside the carton during shipment.

PART LIST :

ITEM	DRAWING	DESCRIPTION	QTY
A		FULL HEADBOARD	1
B		FULL FOOTBOARD	1
C		STORAGE SIDE RAIL	1 SET
D		DRAWER FRAME	2 SETS
E		SLATS	1 SET
F		VERTICAL LEG - 1	2
G		VERTICAL LEG - 2	1
H		VERTICAL LEG - 3	1
I		VERTICAL LEG - 4	1
J		CENTER DRAWER SUPPORT	1
K		CENTER RAIL	1
L		DRAWER SIDE RAIL	2
M		DRAWER FRAME SUPPORT LEGS	2
N		DRAWER FOOTBOARD	4

HARDWARE LIST :

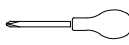
ITEM	DRAWING	DESCRIPTION	QTY
O		JCBC SCREW (M6 x 35mm)	22
P		SPRING WASHER (M8)	22
Q		FLAT WASHER (M8 x 18mm)	22
R		ALLEN KEY (M4 x 65mm)	1
S		PANHEAD SCREW (M4 x 32mm)	26
T		Ø8 x 30mm	8
U		SCREW DRIVER(*)	1

(*) The manufacturer does not provide ITEM U

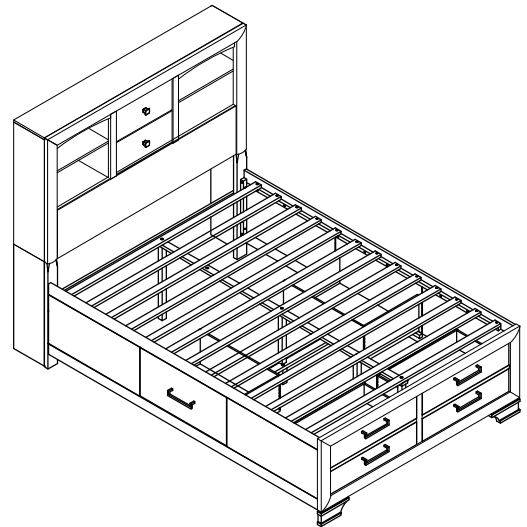

COMPLETED FULL BOOKCASE HEADBOARD

NOTE : MUST TIGHTEN SCREWS PERIODICALLY. WITH USE SCREW MAY BECOME LOOSE. CHECK TIGHTNESS OF ALL SCREWS EVERY 6-8 WEEKS.

CLEANING INSTRUCTION :
 AFTER ASSEMBLE, CLEAN & POLISH THE COMPLETED PARTS IF NECESSARY WITH SOFT CLOTH AND INDUSTRIAL RECOGNIZED FURNITURE POLISH.

MADE IN MALAYSIA

ASSEMBLY INSTRUCTION

MODEL NO: JORDYN - WHITE / GREY - FB - HB - STORAGE & LIGHT DESCRIPTION: FULL STORAGE HEADBOARD W/LIGHT
 JORDYN - WHITE / GREY - FB - FB - FRAME & SLATS FULL STORAGE FOOTBOARD W/FRAME & SLATS
 JORDYN - WHITE / GREY - FB - FB & SR DRAWER 1 FULL 2PCS FOOTBOARD DRAWER & 1PC SIDE RAILS DRAWER
 JORDYN - WHITE / GREY - FB - FB & SR DRAWER 2 FULL 2PCS FOOTBOARD DRAWER & 1PC SIDE RAILS DRAWER
 JORDYN - WHITE / GREY - FB - SR & CENTER STORAGE FULL SIDE RAIL & CENTER STORAGE

Thank you for purchasing this quality product. Be sure to check all packing material carefully for small parts that may have come loose inside the carton during shipment.

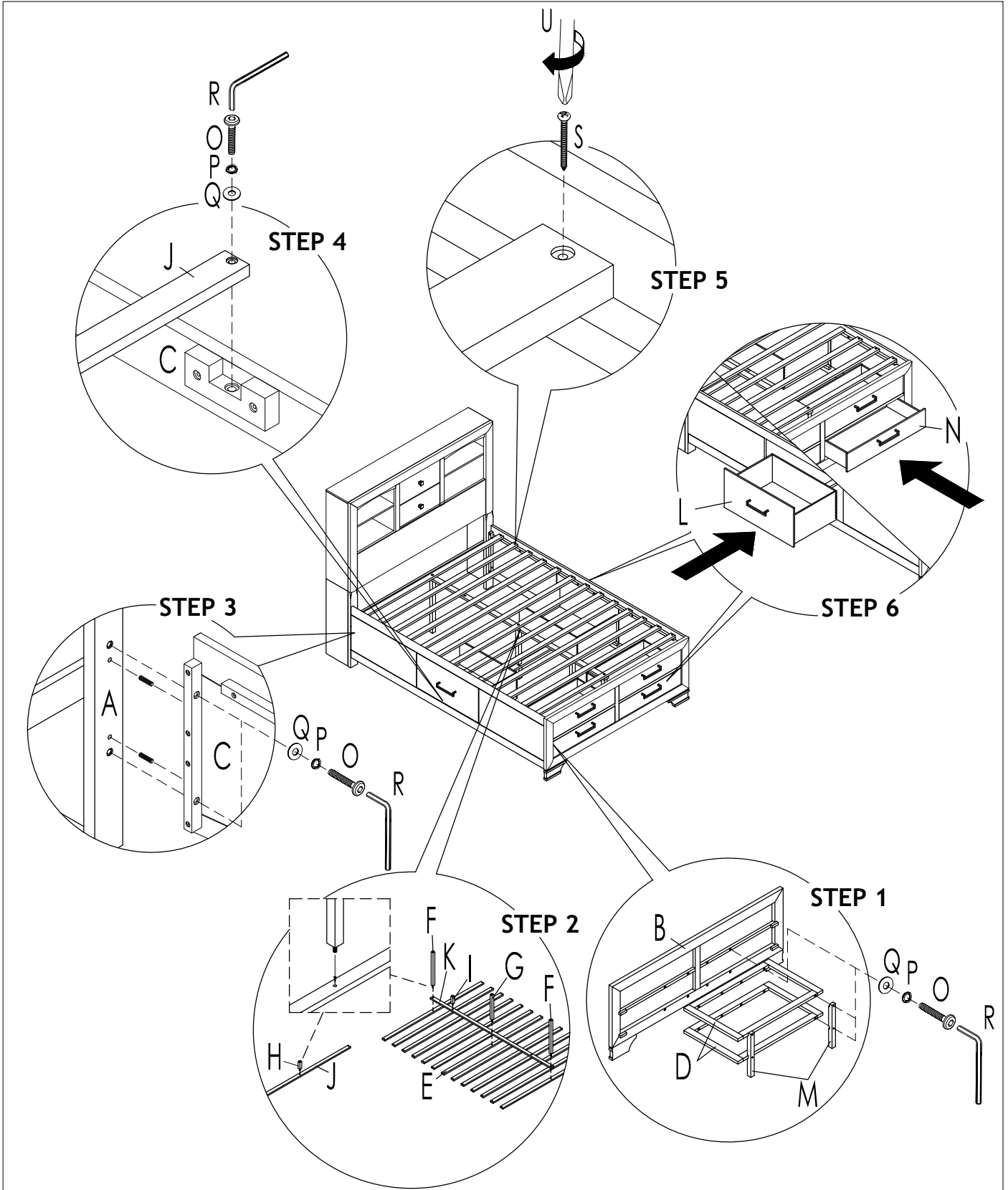

NOTE : MUST TIGHTEN SCREWS PERIODICALLY. WITH USE SCREW MAY BECOME LOOSE. CHECK TIGHTNESS OF ALL SCREWS EVERY 6-8 WEEKS.

CLEANING INSTRUCTION :
 AFTER ASSEMBLE, CLEAN & POLISH THE COMPLETED PARTS IF NECESSARY WITH SOFT CLOTH AND INDUSTRIAL RECOGNIZED FURNITURE POLISH.

MADE IN MALAYSIA

ASSEMBLY INSTRUCTION

MODEL NO: JORDYN-WHITE/GREY-FB-HB-STORAGE & LIGHT

DESCRIPTION: FULL STORAGE HEADBOARD W / LIGHT

Thank you for purchasing this quality product. Be sure to check all packing material carefully for small parts that may have come loose inside the carton during shipment.

PART LIST :

ITEM	DRAWING	DESCRIPTION	QTY
A		FULL HEADBOARD	1
B		LEFT HEADBOARD LEG	1
C		RIGHT HEADBOARD LEG	1
D		SHELF	2

HARDWARE LIST :

ITEM	DRAWING	DESCRIPTION	QTY
E		JCBC SCREW (M6 x 35mm)	12
F		SPRING WASHER (M8)	12
G		FLAT WASHER (M8 x 18mm)	12
H		ALLEN KEY (M4 x 65mm)	1
I		ADAPTER (12V / 1.0A)	1
J		SHELF SUPPORT	8
K		SCREW DRIVER(*)	1

(*) The manufacturer does not provide ITEM K

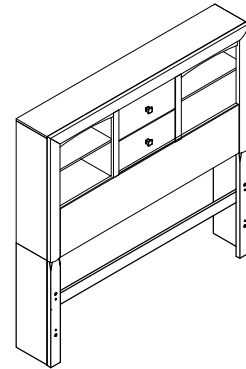

COMPLETED FULL BOOKCASE HEADBOARD

STEP 3

UNSCREWING THE HANDLE SCREW FROM OUTSIDE, TAKE OUT THE HANDLE FROM THE DRAWER AND INSTALL HANDLE AT DRAWER FRONT.

STEP 1

STEP 4

STEP 2

STEP 5

NOTE : MUST TIGHTEN SCREWS PERIODICALLY. WITH USE SCREW MAY BECOME LOOSE. CHECK TIGHTNESS OF ALL SCREWS EVERY 6-8 WEEKS.

CLEANING INSTRUCTION :
AFTER ASSEMBLE, CLEAN & POLISH THE COMPLETED PARTS IF NECESSARY WITH SOFT CLOTH AND INDUSTRIAL RECOGNIZED FURNITURE POLISH.

MADE IN MALAYSIA