







# ASSEMBLY INSTRUCTION

MODEL NO: RILEY

ITEM	DRAWING	DESCRIPTION	QTY
A		HEADBOARD PANEL	1
B		LEFT HEADBOARD LEG	1
C		RIGHT HEADBOARD LEG	1

ITEM	DRAWING	DESCRIPTION	QTY
D		JCB SREW (M8 x 40mm)	6
E		SPRING WASHER (M8 x 15mm)	6
F		FLAT WASHER (M8 x 22mm)	6
G		ALLEN KEY (M5)	1

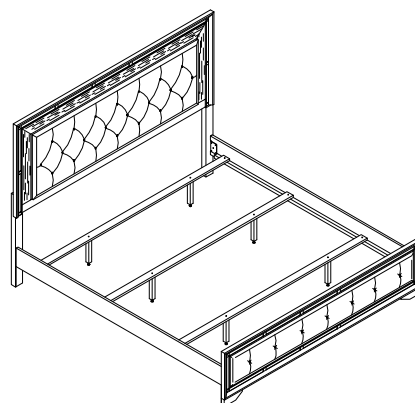

COMPLETE HEADBOARD ASSEMBLY

## Step 1

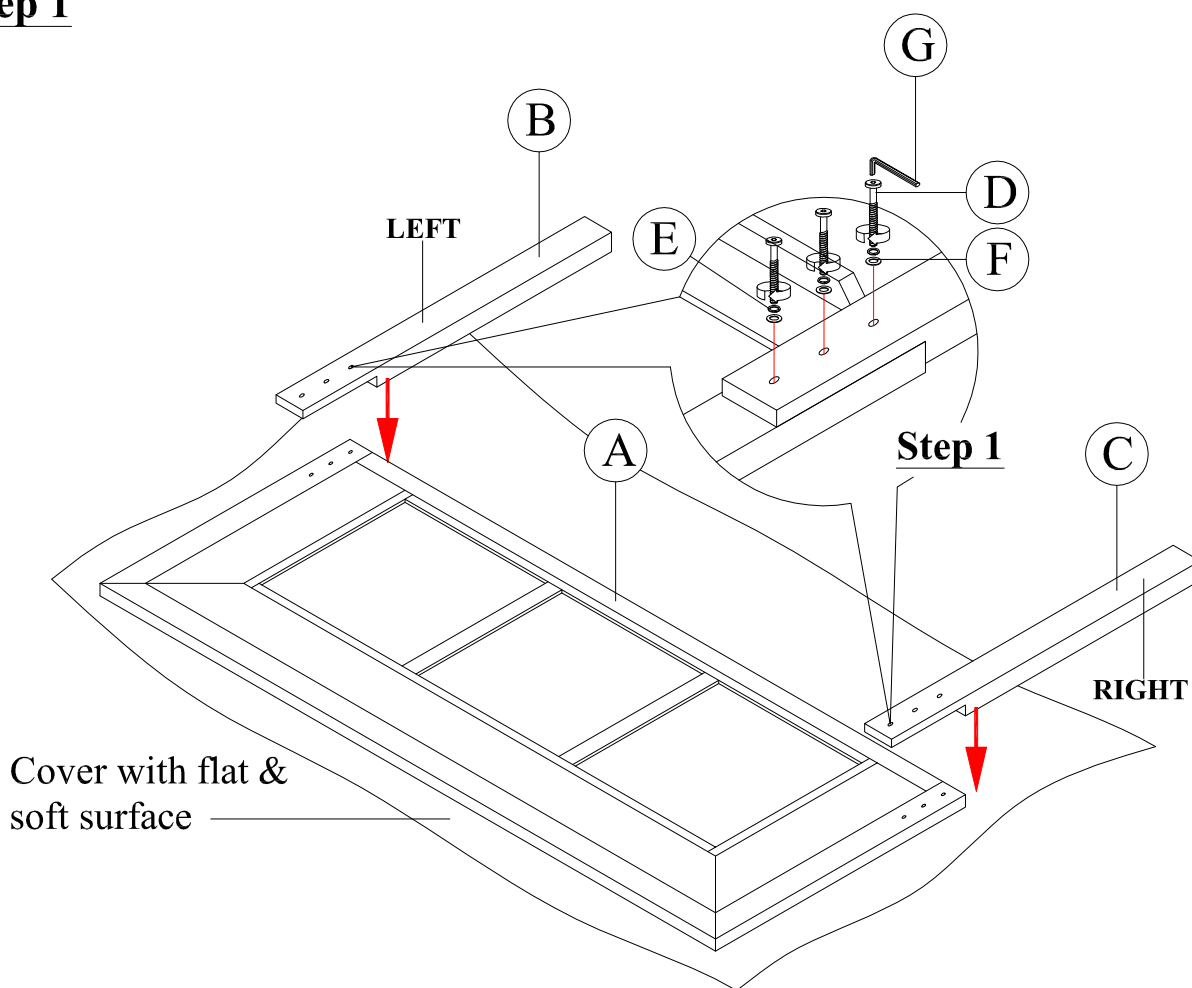

NOTE : MUST TIGHTEN SCREWS PERIODICALLY. WITH USE SCREWS MAY BECOME LOOSE.  
CHECK TIGHTNESS OF ALL SCREWS EVERY 6-8 WEEKS.





### CLEANING INSTRUCTION



After assembled, clean & polish the completed parts if necessary with soft cloth and industrial recognized furniture polish

MADE IN MALAYSIA

# ASSEMBLY INSTRUCTION

MODEL NO: RILEY

ITEM	DRAWING	DESCRIPTION	QTY
A		HEADBOARD	1
B		FOOTBOARD	1
C		SIDE RAIL	2
D		WOODEN SLAT	3

ITEM	DRAWING	DESCRIPTION	QTY
E		WOODEN SUPPORT	6
F		CB SCREW (M4 x 32mm)	6
G		SCREW DRIVER (*)	1

The manufacturer does not provide item G.

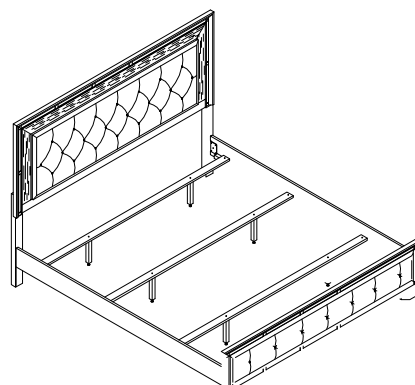

COMPLETE BED ASSEMBLY  
FOOTBOARD AND SIDE RAILS

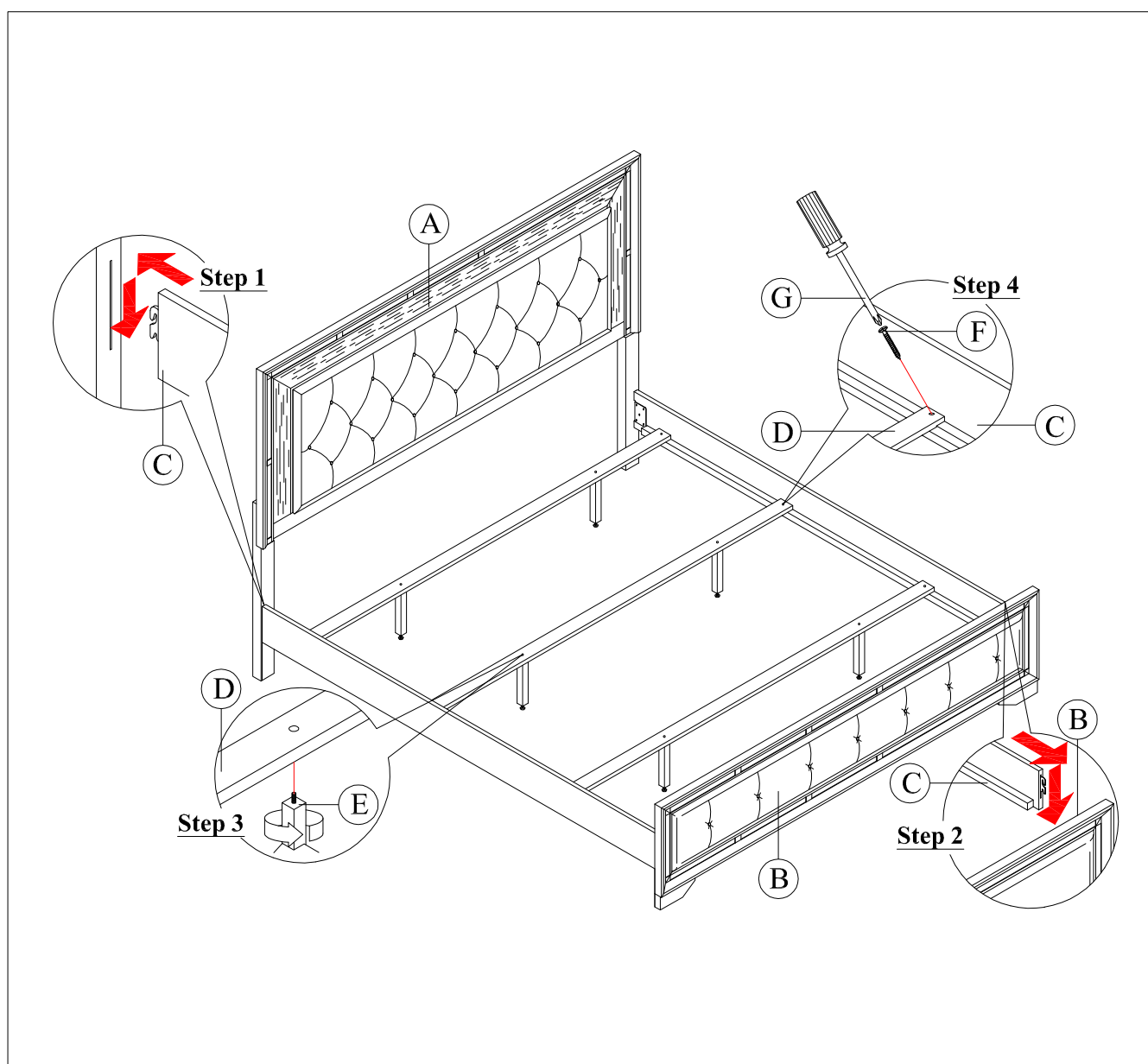

NOTE : MUST TIGHTEN SCREWS PERIODICALLY. WITH USE SCREWS MAY BECOME LOOSE.  
CHECK TIGHTNESS OF ALL SCREWS EVERY 6-8 WEEKS.

### CLEANING INSTRUCTION





After assembled, clean & polish the completed parts if necessary with soft cloth and industrial recognized furniture polish

MADE IN MALAYSIA

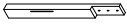
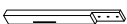
# ASSEMBLY INSTRUCTION

MODEL NO: FULL HEADBOARD

ITEM	DRAWING	DESCRIPTION	QTY
A		HEADBOARD PANEL	1
B		LEFT HEADBOARD LEG	1
C		RIGHT HEADBOARD LEG	1

ITEM	DRAWING	DESCRIPTION	QTY
D		JCBB SCREW (M8 x 40mm)	6
E		SPRING WASHER (M8 x 15mm)	6
F		FLAT WASHER (M8 x 22mm)	6
G		ALLEN KEY (M5)	1

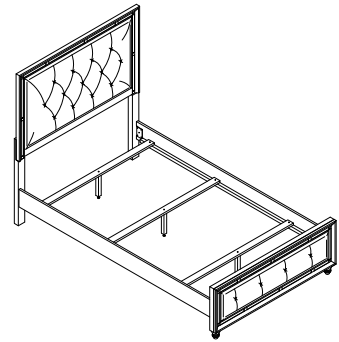

**COMPLETED FULL BED ASSEMBLY**

## Step 1

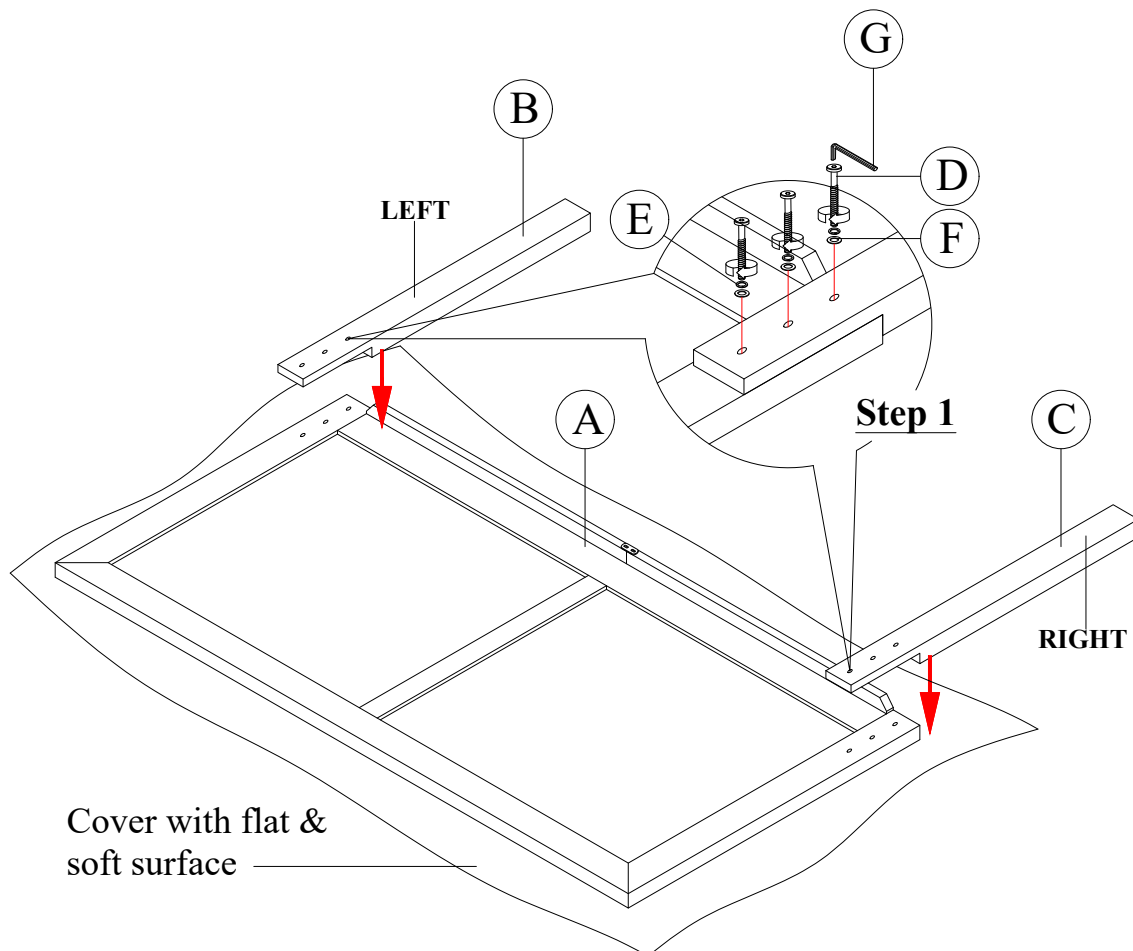

Cover with flat & soft surface

NOTE : MUST TIGHTEN SCREWS PERIODICALLY. WITH USE SCREWS MAY BECOME LOOSE. CHECK TIGHTNESS OF ALL SCREWS EVERY 6-8 WEEKS.

### CLEANING INSTRUCTION





After assembled, clean & polish the completed parts if necessary with soft cloth and industrial recognized furniture polish



MADE IN MALAYSIA

1621 / 1623SV FULL HB

# ASSEMBLY INSTRUCTION

MODEL NO: FULL SIDE RAIL

ITEM	DRAWING	DESCRIPTION	QTY
A		HEADBOARD	1
B		FOOTBOARD	1
C		SIDE RAIL	2
D		WOODEN SLAT	3

ITEM	DRAWING	DESCRIPTION	QTY
E		WOODEN SUPPORT	3
F		CB SCREW (M4 x 32mm)	6
G		SCREW DRIVER (*)	1

The manufacturer does not provide item G.

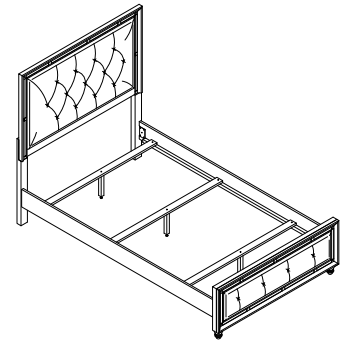

**COMPLETED FULL BED  
ASSEMBLY**

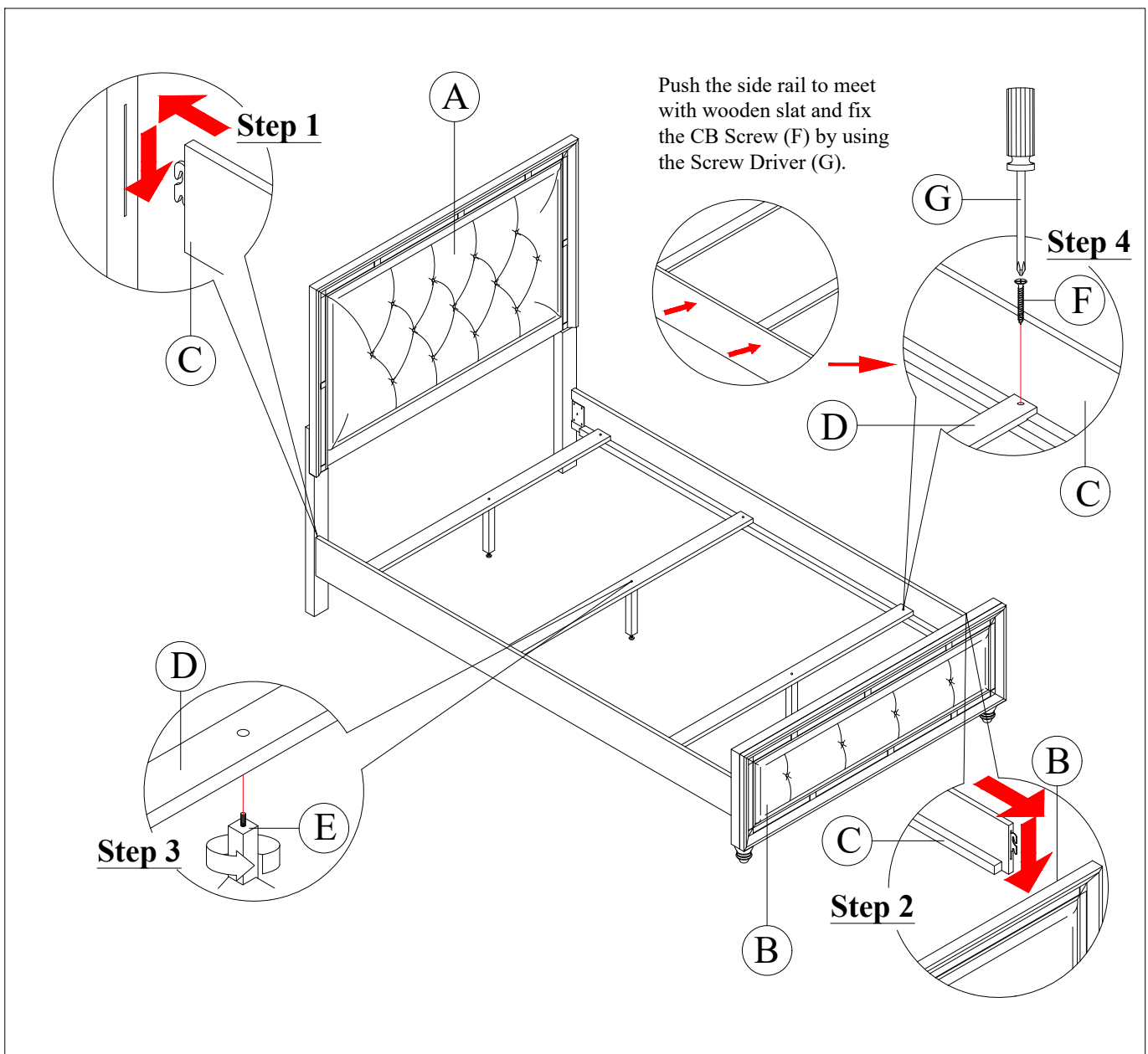

NOTE : MUST TIGHTEN SCREWS PERIODICALLY. WITH USE SCREWS MAY BECOME LOOSE.  
CHECK TIGHTNESS OF ALL SCREWS EVERY 6-8 WEEKS.

**CLEANING INSTRUCTION**

After assembled, clean & polish the completed parts if necessary with soft cloth and industrial recognized furniture polish

MADE IN MALAYSIA

1621 / 1623SV FULL SR